



CH/CX



PCB Connectors

smiths

HYPERTAC CONTACT

wire sleeve before
insertion of pin



pin partially
inserted into sleeve



pin completely
inserted into sleeve



HYPERTAC SOCKET CONTACT BRIEFLY

HYPERTAC (= HYPERboloid conTACT) is a socket contact designed and manufactured in such a manner that, implementing advanced micromechanics technology, satisfies performance requirements previously considered impossible.

The shape of the sleeve is formed by a springy wires special arrangement. When pin is inserted into this sleeve every wire stretches to accommodate it, so that wires wrap themselves around pin providing lines of current paths.

HYPERTAC SOCKET CONTACT, ADVANTAGES

1. ENVIRONMENTAL ADVANTAGES:

- no local hot spot (uniform current densities);
- self-cleaning pin insertion.

2. MECHANICAL ADVANTAGES:

- exceptional electrical continuity under vibration and shock (very low mass of springy wires, 360° current paths around pin and redundant current paths);
- low contact engagement and separation forces;
- long contact life (stable time/life contact resistance).

3. ELECTRICAL ADVANTAGES:

- lower contact resistance (redundant current paths);
- higher current rating (lower contact resistance);
- uniform current densities (lower current gradients).

4. USER'S ADVANTAGES:

- HYPERTAC socket contact mates every conventional cylindrical pin contact.

CONTENTS

CHB/CHC Series	2
Requirements	2
How to order.....	3
Connector dimensions	4
Contact terminal styles	6
Hardware	
Codify	10
For test connector	11
Floating	12
With key	13
Screw locking	14
Compatibility between fixings	16
Mountin pattern and panel cut-out	17
Tools and replacement contacts	25
Special qualifications	
CHB connector qualified to MIL-DTL-55302	26
CHC connector qualified to TEL-80-5935	27
CXB Series	28
Requirements	28
How to order.....	29
Connector dimensions	30
Contact terminal style	33
Hardware	
Codify	37
For test connector	38
Screw locking	39
Compatibility between fixings	40
Mountin pattern and panel cut-out	41
Tools	52
Assembling scheme for coax contact	53

CHB/CHC Series



CHB and CHC are PCB connectors conforming to BS9525, NF C 93-424 and ESA SCC 3401.

Contact arrangement is offset-grid pattern, two or three contact rows within dielectric connector body, with 2.54 mm center-to-center contact spacing in each row and 2.54 mm row-to-row spacing.

Contact size is 0.6 mm nominal pin DIA.

Configurations are from 17 to 144 contact positions.

CHB and CHC connectors are also available with special qualification (see pages 26 and 27)

REQUIREMENTS

APPLIED DOCUMENTS

REQUIREMENTS		APPLIED DOCUMENTS
MATERIAL		
Body Contacts	DAP 5553 Brass CuBe	MIL-M-24519 ASTM B16 ASTM B197
Hardware	Phosphor-Bronze Stainless steel CuBe	ASTM B139 ASTM A582 ASTM B196
FINISHES		
Contacts Hardware	Gold Passivation Nichel plated	ASTM B488 ASTM A967 QQ-N-290
MECHANICAL		
Mating/Unmating force Contact life	56g max 100000 insertion	- -
ELECTRICAL		
Current rating ⁽¹⁾ Contact resistance Dielectric withstanding voltage Insulation resistance	5.0 A ≤ 10.0 mΩ 1400 VRMS, 60 Hz a.s.l. ≥ 5000 MΩ at 500 VDC	- - - -
PHYSICAL AND ENVIROMENTAL		
Shock Vibration Operating range CVCM TML	- - -65°C +125°C <0.1% <1.0%	In accordance with MIL-STD-1344 In accordance with MIL-STD-1344 - - -

⁽¹⁾ Consult factory for details

How to order

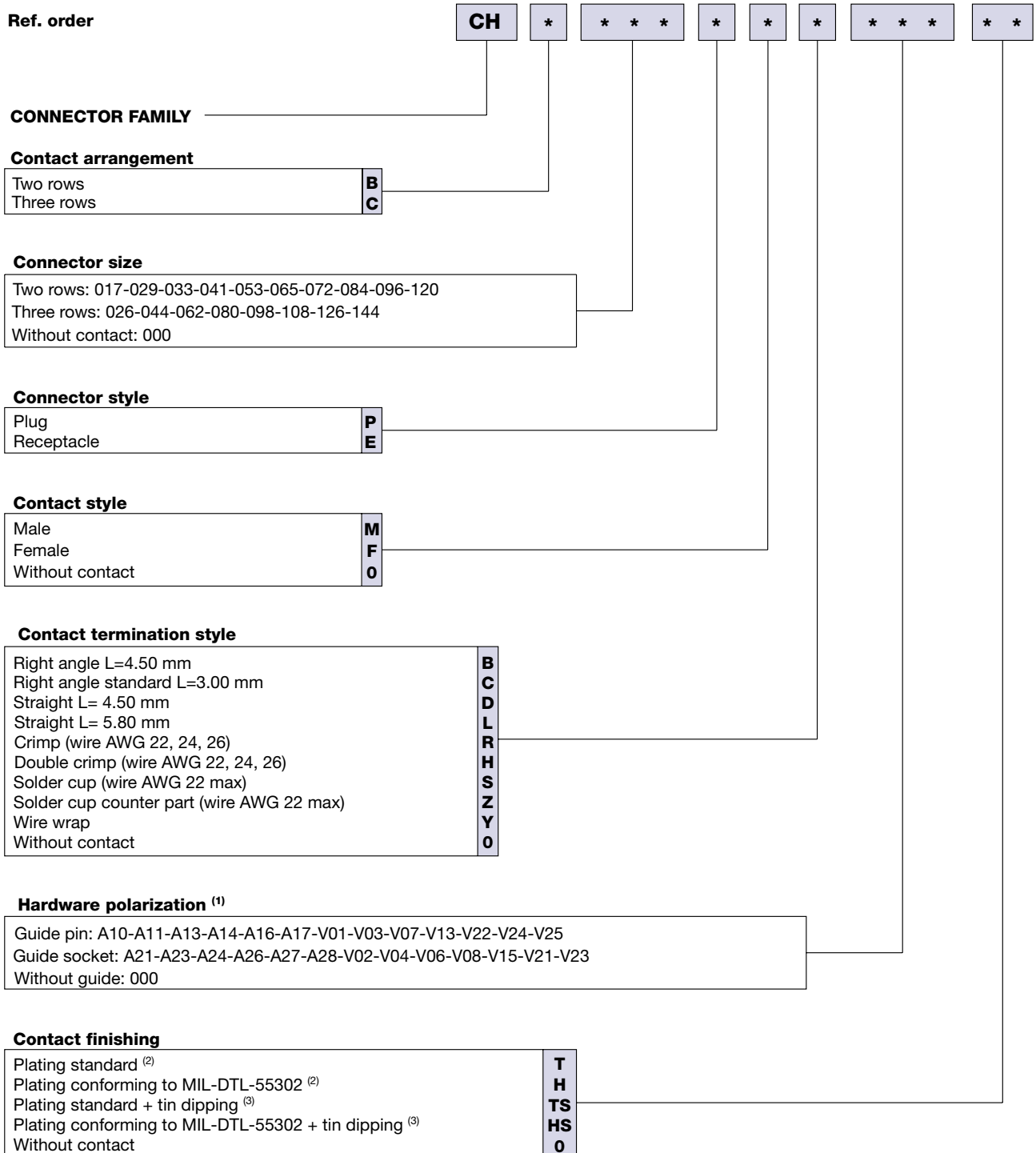

⁽¹⁾ Standard coding: pos. C3

⁽²⁾ T Reference:

Functional part (Mating area): 0.25 µm Gold per ASTM B-488 type II Grade C on 2 µm Ni per QQ N-290

Termination area: 0.15 µm Gold per ASTM B-488 type II Grade C on 2 µm Ni per QQ N-290

H Reference:

Functional part (Mating area): 1.27 µm Gold per ASTM B-488 type II Grade C on 2 µm Ni per QQ N-290

Termination area: 0.508 µm Gold per ASTM B-488 type II Grade C on 2 µm Ni per QQ N-290

⁽³⁾ This finishing is only for dip solder contacts.

Connector dimensions CHB017 to CHB065

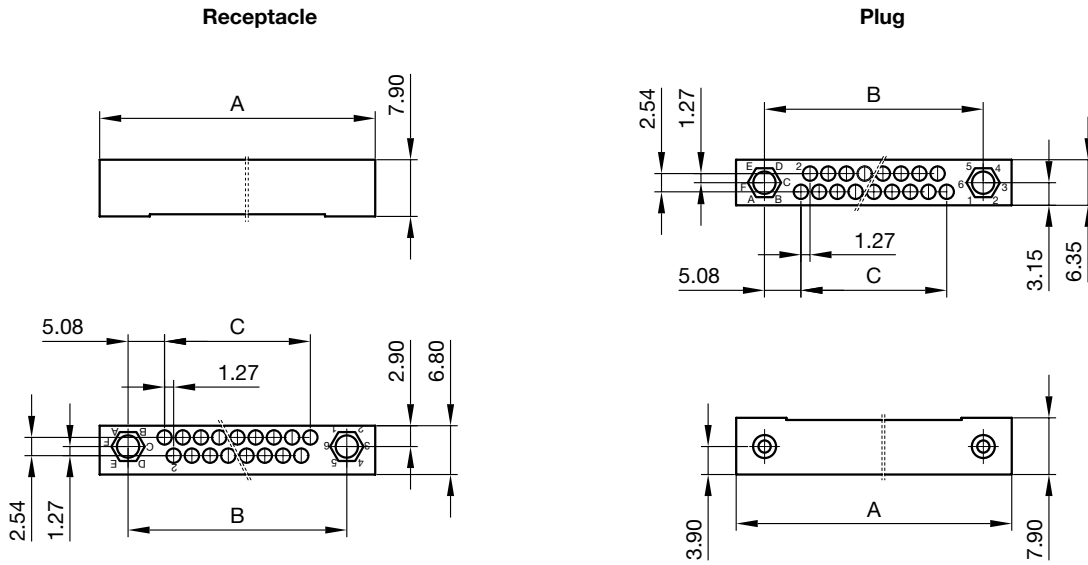

No of contacts	17	29	33	41	53	65
A	38.40	53.60	58.70	68.90	84.10	99.40
B	30.48	45.72	50.80	60.96	76.20	91.44
C	20.32	35.56	40.64	50.80	66.04	81.28

Connector dimensions CHB072 to CHB120

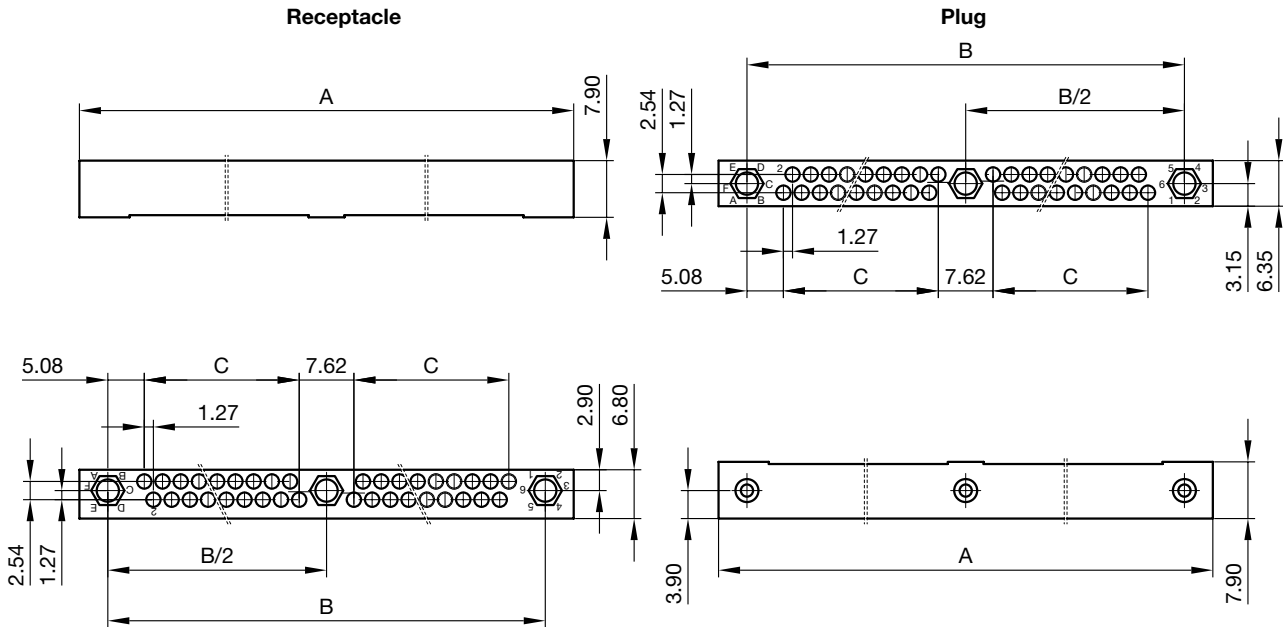

No of contacts	72	84	96	120
A	114.60	129.80	145.10	175.50
B	106.68	121.92	137.16	167.64
C	44.45	52.07	59.69	74.93

Dimensions are in millimeters

Connector dimensions CHC026 to CHC098

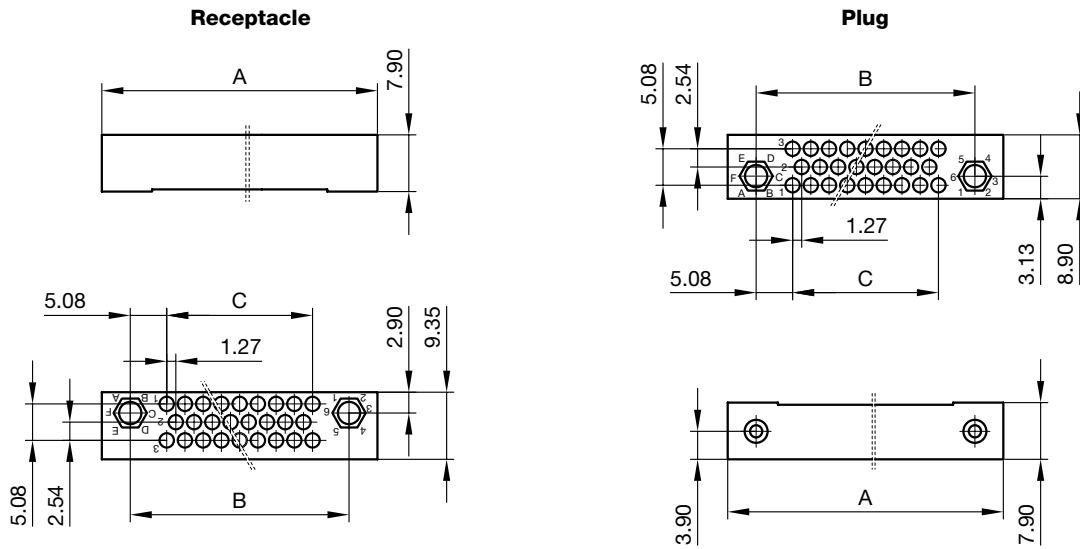

No of contacts	26	44	62	80	98
A	38.40	53.60	68.90	84.10	99.40
B	30.48	45.72	60.96	76.20	91.44
C	20.32	35.56	50.80	66.04	81.28

Connector dimensions CHC108 to CHC144

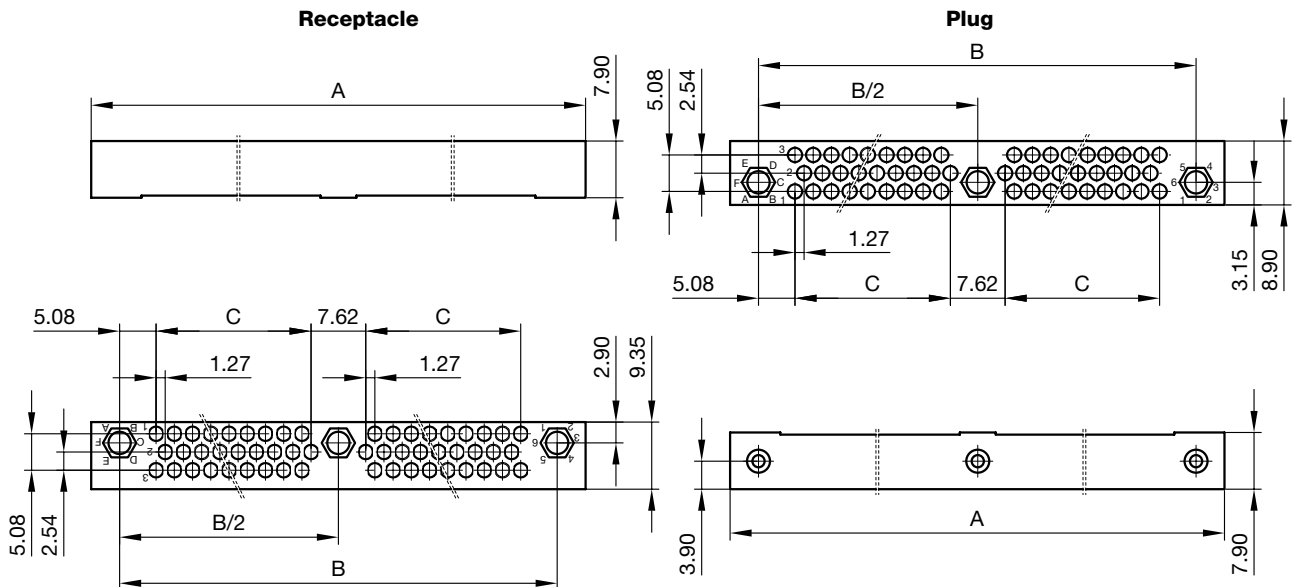

No of contacts	108	126	144
A	114.60	129.80	145.10
B	106.68	121.92	137.16
C	44.45	52.07	59.69

Dimensions are in millimeters

Contact terminal style for plug connector

Terminal style	Serie	Female	Male
B/C see note 1)	CHB		
	CHC		
D/L	CHB		
	CHC		
R Accept AWG 22, 24, 26	CHB	 Contacts supplied NOT ASSEMBLED	 Contacts supplied NOT ASSEMBLED
	CHC	 Contacts supplied NOT ASSEMBLED	 Contacts supplied NOT ASSEMBLED

Notes:
 1) The connector is supplied with positioner to assist the contacts insertion in the PCB
 2) Dimensions are in millimeters

Contact terminal style for plug connector

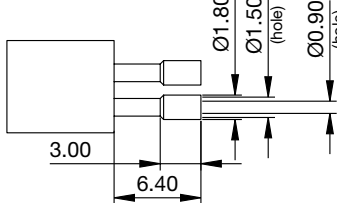
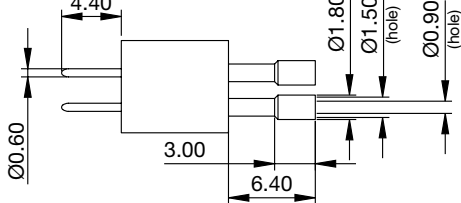
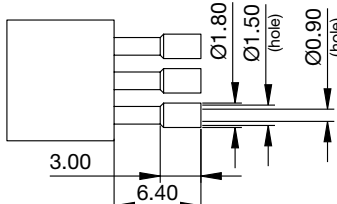
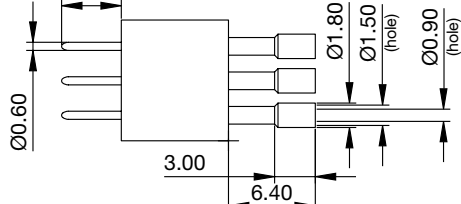
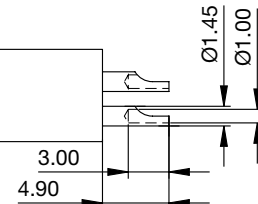
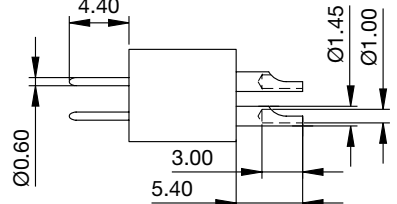
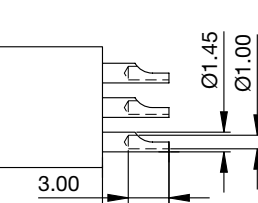
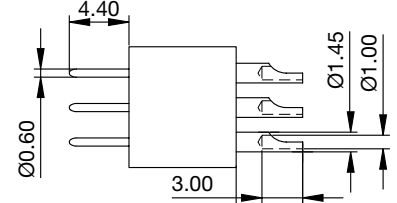
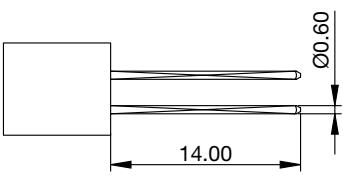
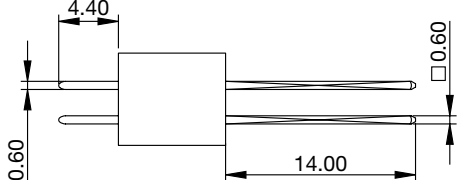
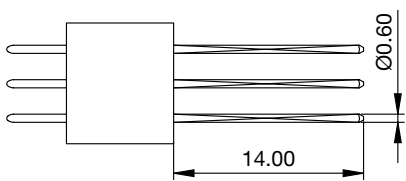
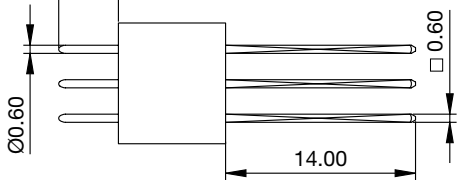
Terminal style	Serie	Female	Male
H ¹⁾ Accept AWG 22, 24, 26	CHB	 <p>Contacts supplied NOT ASSEMBLED</p>	 <p>Contacts supplied NOT ASSEMBLED</p>
	CHC	 <p>Contacts supplied NOT ASSEMBLED</p>	 <p>Contacts supplied NOT ASSEMBLED</p>
S/Z Accept up to AWG 22	CHB	 <p>Ref. Z: solder cup staggered orientation</p>	 <p>Ref. Z: solder cup staggered orientation</p>
	CHC	 <p>Ref. Z: solder cup staggered orientation</p>	 <p>Ref. Z: solder cup staggered orientation</p>
Y	CHB		
	CHC		

Notes:
 1) The connector is supplied with an insulation diaphragm to eliminate the possibility of electric discharge wiring side
 2) Dimensions are in millimeters

Contact terminal style for receptacle connector

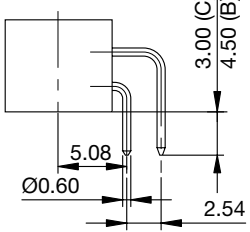
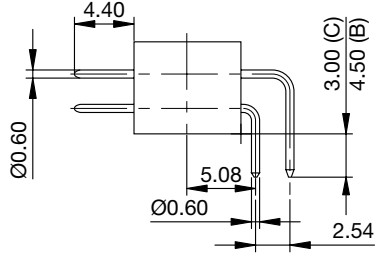
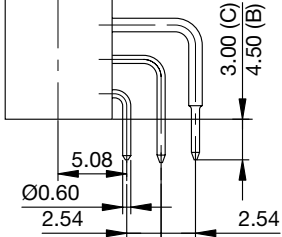
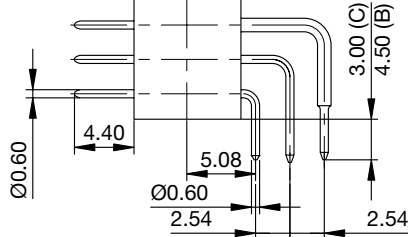
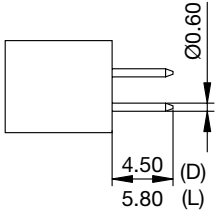
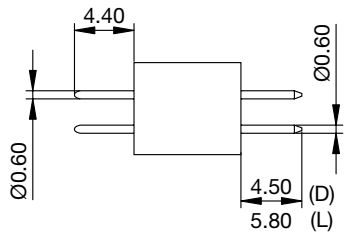
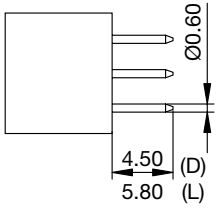
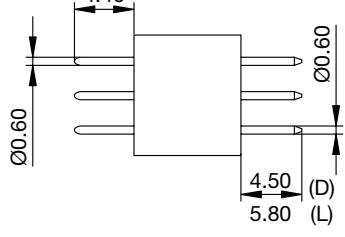
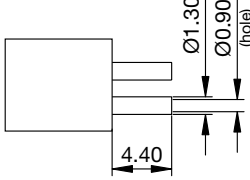
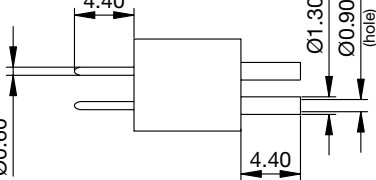
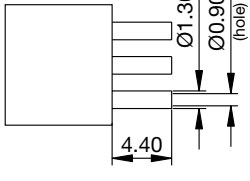
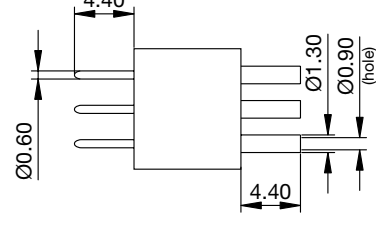
Terminal style	Serie	Female	Male
B/C ¹⁾	CHB		
	CHC		
D/L	CHB		
	CHC		
R Accept AWG 22, 24, 26	CHB	 Contacts supplied NOT ASSEMBLED	 Contacts supplied NOT ASSEMBLED
	CHC	 Contacts supplied NOT ASSEMBLED	 Contacts supplied NOT ASSEMBLED

Notes:
 1) The connector is supplied with positioner to assist the contacts insertion in the PCB
 2) Dimensions are in millimeters

Contact terminal style for receptacle connector

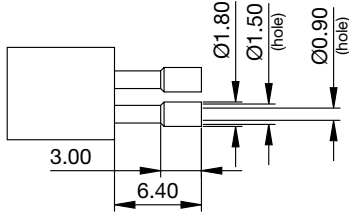
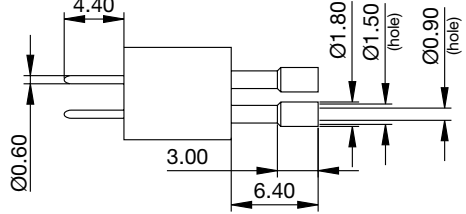
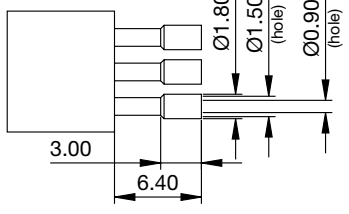
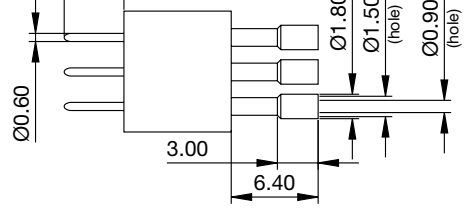
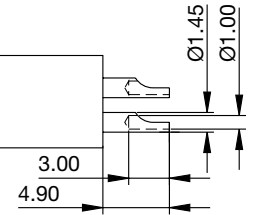
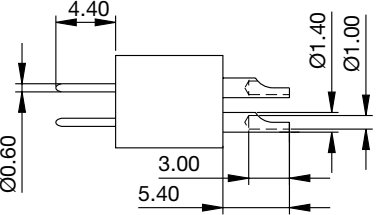
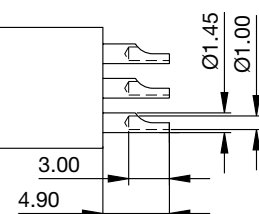
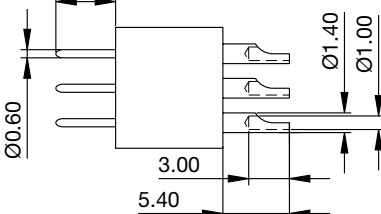
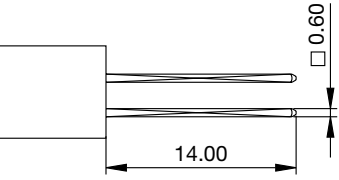
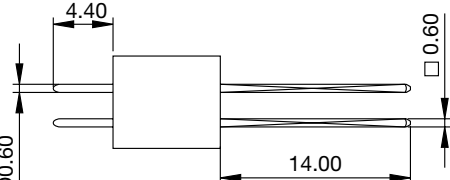
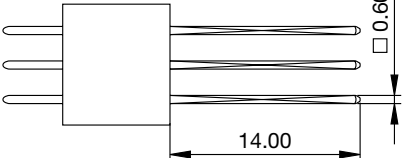
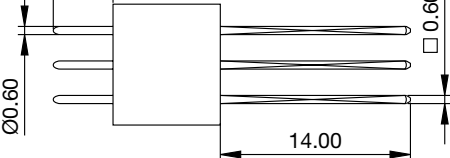
Terminal style	Serie	Female	Male
H ¹⁾ Accept AWG 22, 24, 26	CHB	 <p>Contacts supplied NOT ASSEMBLED</p>	 <p>Contacts supplied NOT ASSEMBLED</p>
	CHC	 <p>Contacts supplied NOT ASSEMBLED</p>	 <p>Contacts supplied NOT ASSEMBLED</p>
S/Z Accept up to AWG 22	CHB	 <p>Ref. Z: solder cup staggered orientation</p>	 <p>Ref. Z: solder cup staggered orientation</p>
	CHC		
Y	CHB		
	CHC		

Notes:
 1) The connector is supplied with an insulation diaphragm to eliminate the possibility of electric discharge wiring side
 2) Dimensions are in millimeters

Codify hardware

Ref.	For connector	Lateral fixing	Central fixing
A10	PLUG		
A11	PLUG RECEPTACLE		
A14	RECEPTACLE		
A21	PLUG RECEPTACLE		
A24	PLUG RECEPTACLE		
A27	RECEPTACLE		

Notes
 1) 0.10 N*m (1.1 Kg*cm) torque
 2) 0.24 N*m (2.5 Kg*cm) torque
 3) Dimensions are in millimeters

Hardware for test connector

Ref.	For connector	Lateral fixing	Central fixing
A16	PLUG		
A17	PLUG RECEPTACLE		
A26	PLUG RECEPTACLE		
A28	PLUG RECEPTACLE		

Notes

- 1) 0.10 N*m (1.1 Kg*cm) torque
- 2) 0.24 N*m (2.5 Kg*cm) torque
- 3) Dimensions are in millimeters

Floating hardware

Ref.	For connector	Lateral fixing	Central fixing
A13	PLUG RECEPTACLE only CHB 017+065 CHC 026+098		
A23	PLUG RECEPTACLE only CHB 017+065 CHC 026+098		

Notes

- 1) 0.24 N*m (2.5 Kg*cm) torque
- 2) Dimensions are in millimeters

Hardware with key

Ref.	For connector	Lateral fixing	Central fixing
V01	PLUG RECEPTACLE		
V03	PLUG		
V02	PLUG RECEPTACLE		
V04	PLUG RECEPTACLE		
V06	PLUG only CHB 017+065 CHC 026+098		

Notes
 1) 0.10 N*m (1.1 Kg*cm) torque
 2) 0.24 N*m (2.5 Kg*cm) torque
 3) Dimensions are in millimeters

Screw locking hardware

Ref.	For connector	Lateral fixing	Central fixing
V07	PLUG RECEPTACLE		
V13	PLUG RECEPTACLE		
V22	RECEPTACLE CHB 017-065 CHC 026-098		
V24	PLUG		
V25	PLUG RECEPTACLE		

- Notes
 1) 0.10 N*m (1.1 Kg*cm) torque
 2) 0.24 N*m (2.5 Kg*cm) torque
 3) 0.35 N*m (3.8 Kg*cm) torque
 4) Dimensions are in millimeters







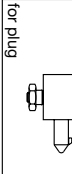
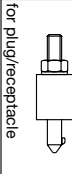
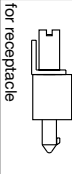
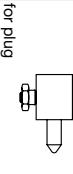
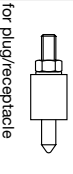
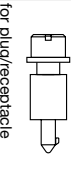

Screw locking hardware

Ref.	For connector	Lateral fixing	Central fixing
V08	PLUG		
V15	PLUG RECEPTACLE		
V21	PLUG only CHB 017+065 CHC 026+098		
V23	PLUG RECEPTACLE		

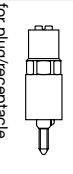
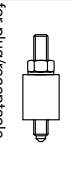
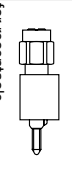
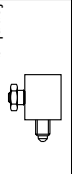
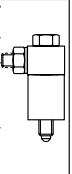
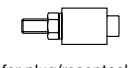
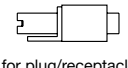
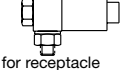
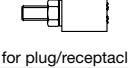
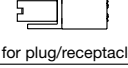
Notes

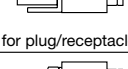
- 1) 0.10 N*m (1.1 Kg*cm) torque
- 2) 0.24 N*m (2.5 Kg*cm) torque
- 3) 0.35 N*m (3.8 Kg*cm) torque
- 4) Dimensions are in millimeters

Compatibility between fixings

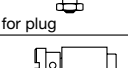
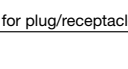
		 for plug	 for plug/receptacle	 for receptacle	 for plug	 for plug/receptacle	 for plug/receptacle	 for plug/receptacle	 for plug	 for plug/receptacle	 for plug/receptacle	 for receptacle	 for plug	 for plug/receptacle
		A10	A11	A14	A16	A17	A13	V01	V03	V07	V13	V22	V24	V25
 for plug/receptacle	A21	*	*	*	*	*	*							
 for plug/receptacle	A24	*	*	*	*	*	*							
 for receptacle	A27	*	*	*	*	*	*							
 for plug/receptacle	A26	*	*	*	*	*	*							
 for plug/receptacle	A28	*	*	*	*	*	*							
 for plug/receptacle	A23	*	*	*	*	*	*							
 for plug/receptacle	V02							*	*					
 for plug/receptacle	V04							*	*					
 for plug	V06							*	*					
 for plug	V08									*				
 for plug/receptacle	V15									*				
 for plug	V21											*		
 for plug/receptacle	V23										*		*	*

Mounting pattern for two row connectors with two fixings

Mounting pattern for plug connector with fixing type:
A10, A16, V03, V06, V08, V21, V24 (view component side)

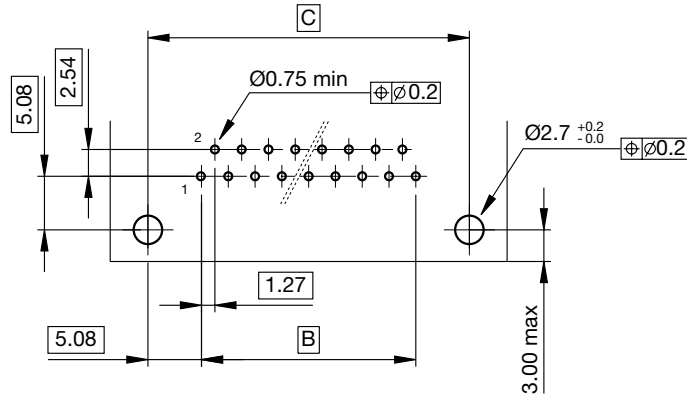

Mounting pattern for plug and receptacle connector with fixing type:
A11, A17, A21, A26, V02, V13, V15 (view component side)

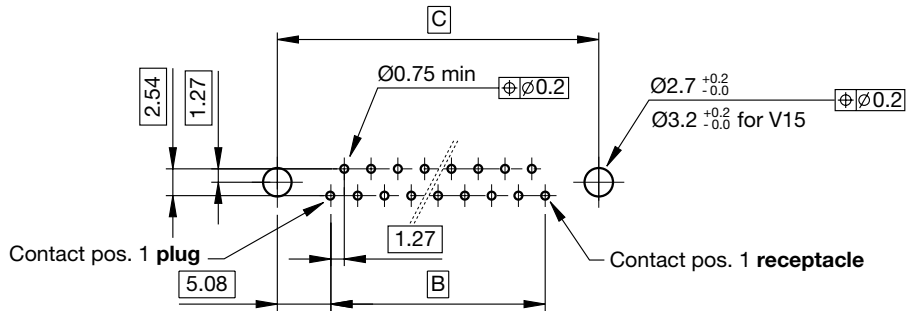

Mounting pattern for plug and receptacle connector with fixing type:
A14, A24, A27, A28, V04, V25 (view component side)

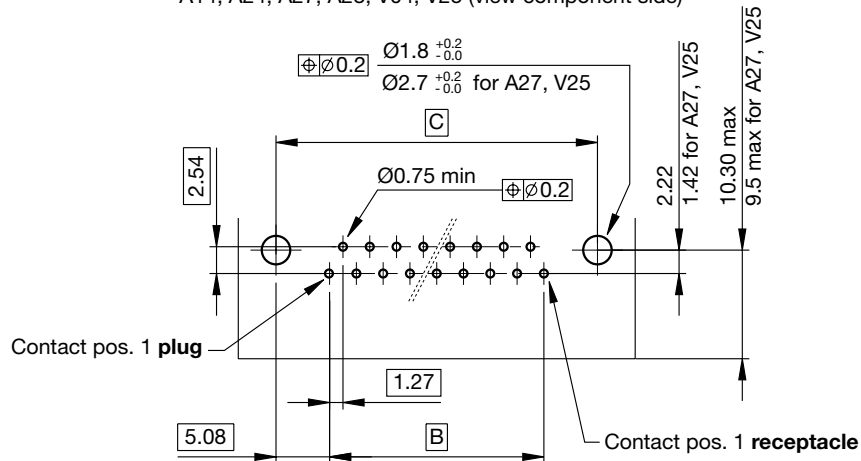

Contact No	17	29	33	41	53	65
B	20.32	35.56	40.64	50.80	66.04	81.28
C	30.48	45.72	50.80	60.96	76.2	91.44

Dimensions are in millimeters

Panel cut-out for two row connectors with two fixings

Panel cut-out for fixing hardware

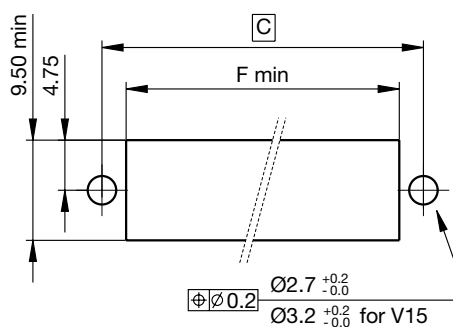

Panel cut-out for floating hardware

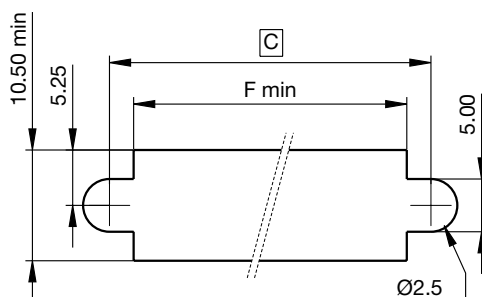

Contact No	17	29	33	41	53	65
C	30.48	45.72	50.8	60.96	76.2	91.44
F	25.9	41.1	46.2	56.4	71.6	86.9

Dimensions are in millimeters

Mounting pattern for two row connectors with three fixings

Mounting pattern for plug connector with fixing type:
A10, A16, V03, V24, V08 (view component side)

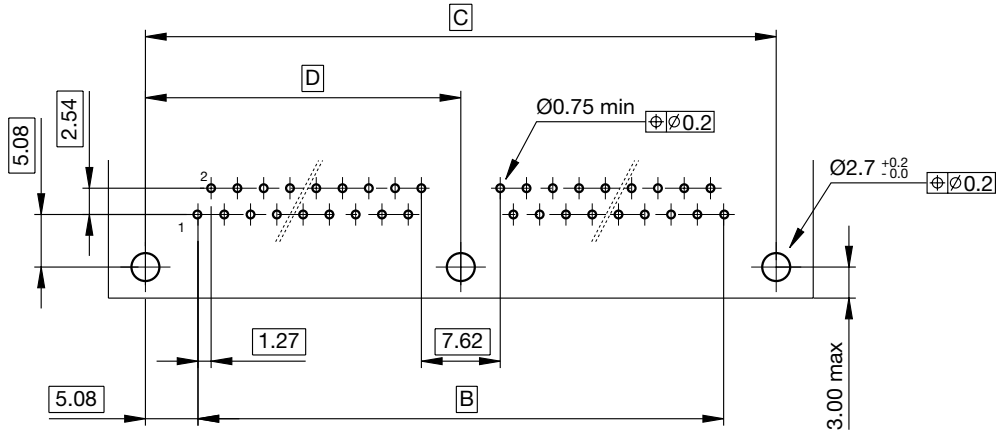

Mounting pattern for plug and receptacle connector with fixing type:
A11, A17, A21, A26, V02, V13, V15 (view component side)

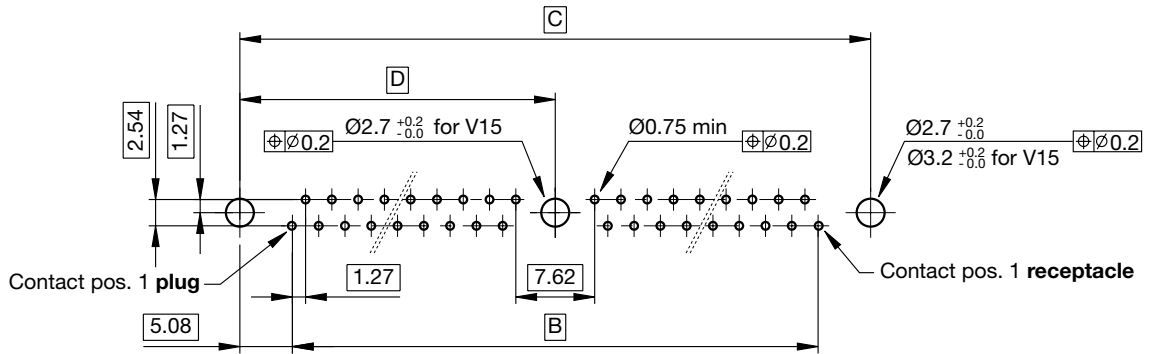

Mounting pattern for plug and receptacle connector with fixing type:
A14, A24, A27, A28, V04, V25 (view component side)

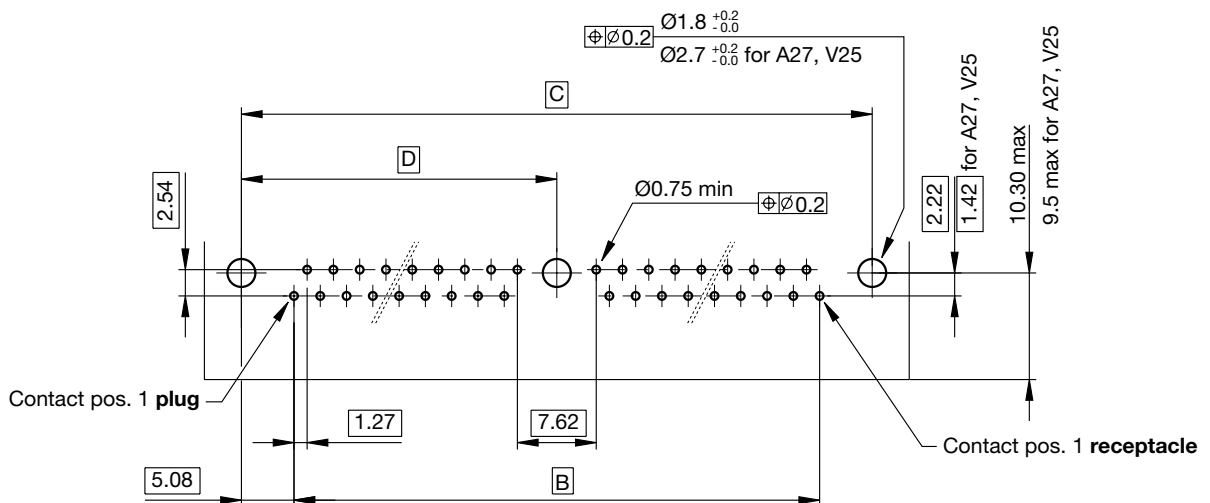

Contact No	72	84	96	120
B	96.52	111.76	127	157.48
C	106.68	121.92	137.16	167.64
D	53.34	60.96	68.58	83.82

Dimensions are in millimeters

Panel cut-out for two row connectors with three fixings

Panel cut-out for fixing hardware

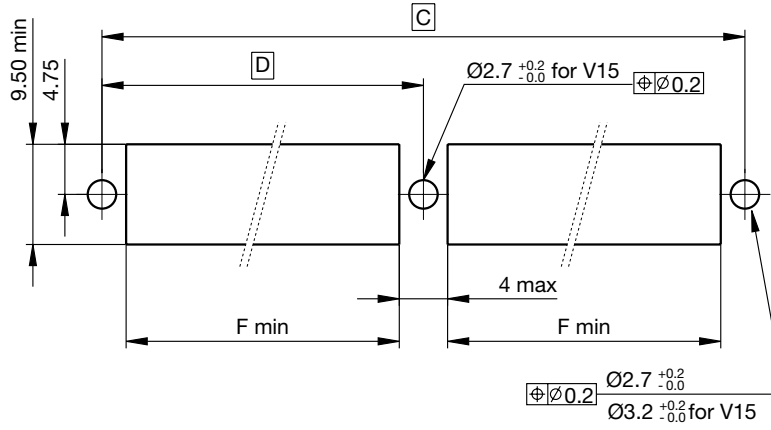

Contact No	72	84	96	120
C	106.68	121.92	137.16	167.64
D	53.34	60.96	68.58	83.82
F	48.5	56	63.6	78.8

Dimensions are in millimeters

Mounting pattern for three row connectors with two fixings

Mounting pattern for plug connector with fixing type:
A10, A16, V03, V06, V08, V21, V24 (view component side)

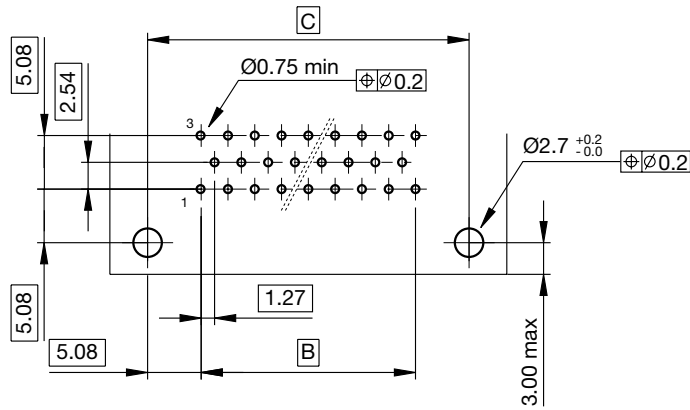

Mounting pattern for plug and receptacle connector with fixing type:
A11, A17, A21, A26, V02, V13, V15 (view component side)

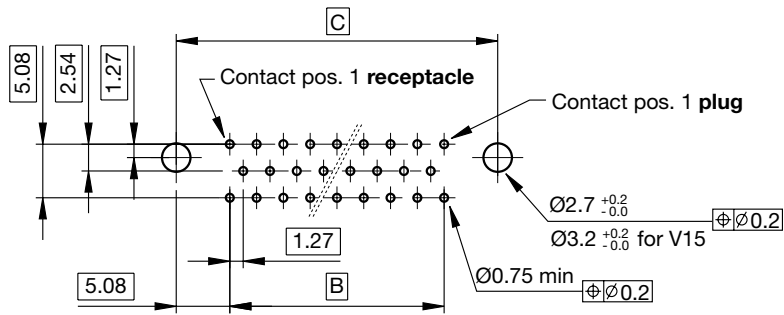

Mounting pattern for plug and receptacle connector with fixing type:
A14, A24, A27, A28, V04, V25 (view component side)

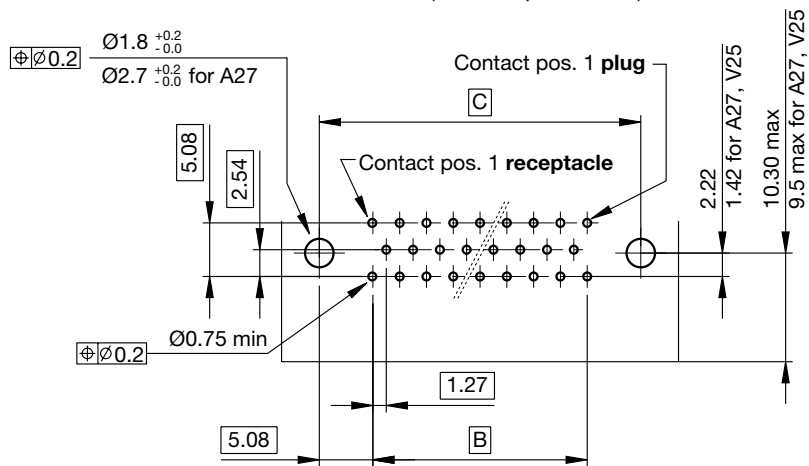

Contact No	26	44	62	80	98
B	20.32	35.56	50.8	66.04	81.28
C	30.48	45.72	60.96	76.2	91.44

Dimensions are in millimeters

Panel cut-out for three row connectors with two fixings

Panel cut-out for fixing hardware

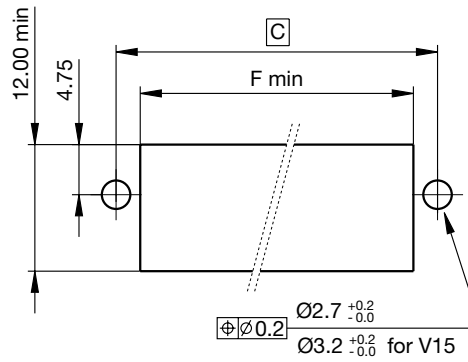

Panel cut-out for floating hardware

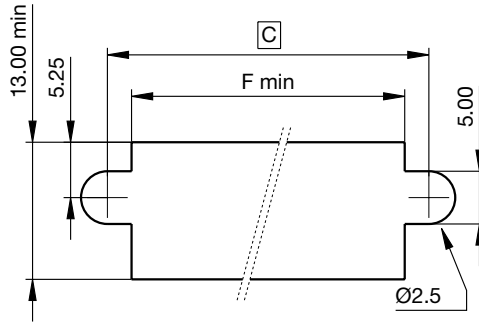

Contact No	26	44	62	80	98
C	30.48	45.72	60.96	76.2	91.44
F	25.9	41.1	56.4	71.6	86.9

Mounting pattern for three row connectors with three fixings

Mounting pattern for plug connector with fixing type:
A10, A16 V03, V08, V24 (view component side)

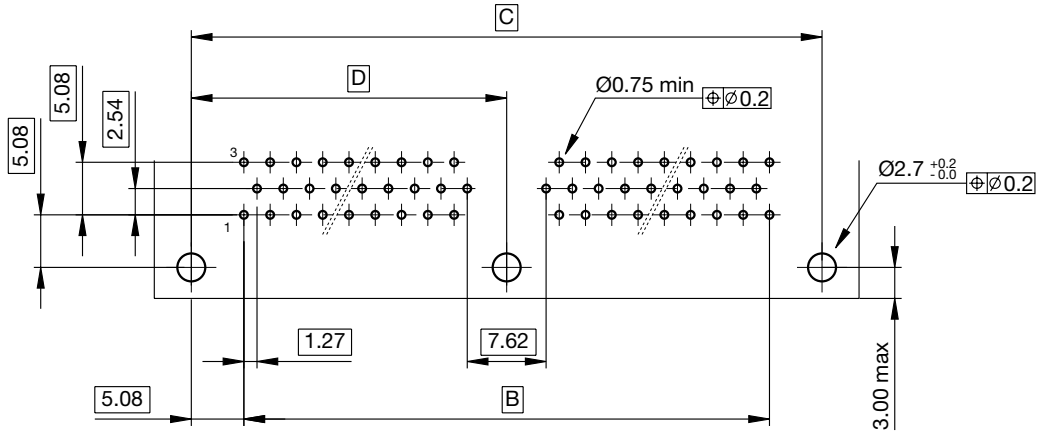

Mounting pattern for plug and receptacle connector with fixing type:
A11, A17, A21, A26, V02, V13, V15 (view component side)

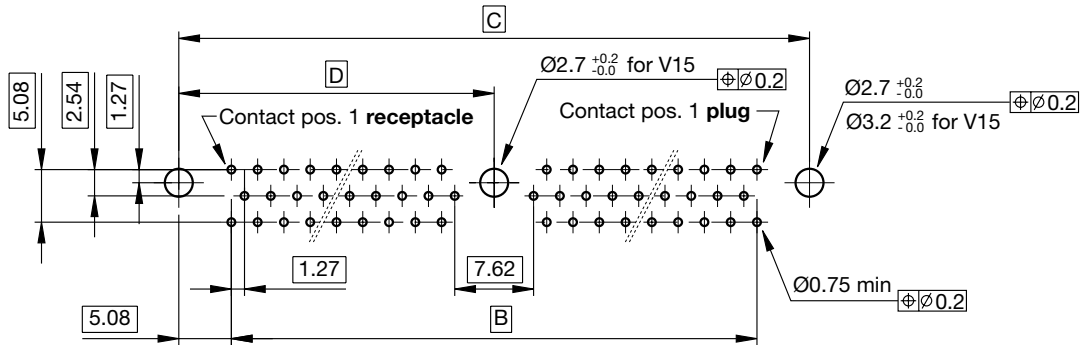

Mounting pattern for plug and receptacle connector with fixing type:
A14, A24, A27, A28, V04, V25 (view component side)

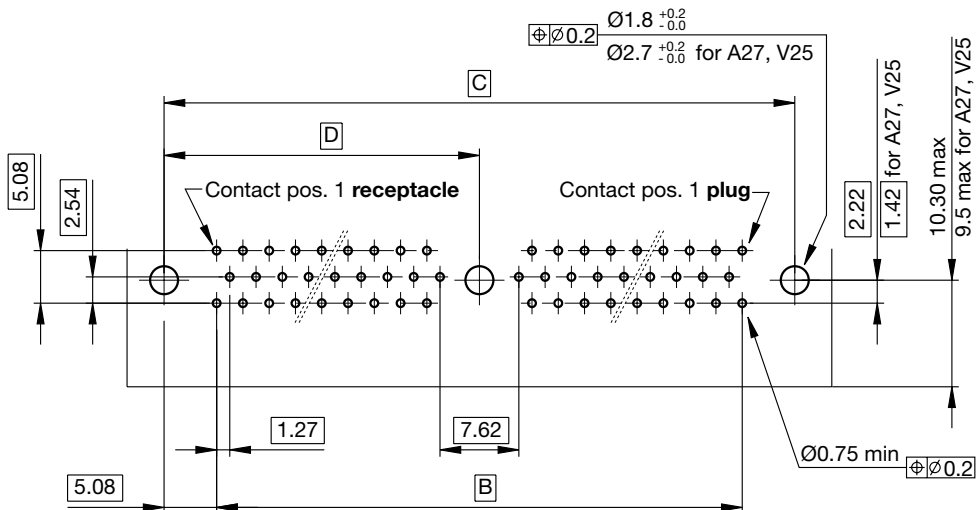

Contact No	108	126	144
B	96.52	111.76	127
C	106.68	121.92	137.16
D	53.34	60.96	68.58

Dimensions are in millimeters

Panel cut-out for three row connectors with three fixings

Panel cut-out for fixing hardware

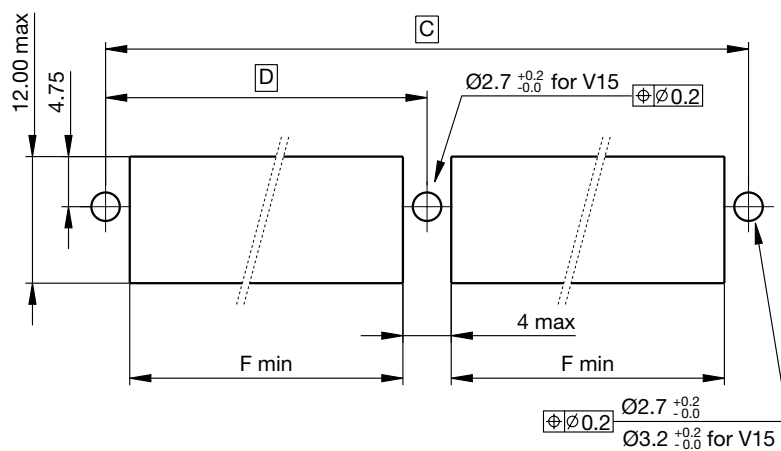

Contact No	108	126	144
C	106.68	121.92	137.16
D	53.34	60.96	68.58
F	48.5	56	63.6

Dimensions are in millimeters

Tools

Extraction tool S/DEM/6/0060

Insertion tool S/MONT/1/0060

Tool for wire-wrap connection Consult factory

NOTES FOR WIRE-WRAP CONNECTION

AWG	Ø cable (mm)	No coil	L* (mm)
30	0.25	8	25
28	0.32	7	23
26	0.4	6	23

(*) stripping length

CRIMP TOOL

Contact type	Crimp tool	Crimp positioner	Crimp setup			L* (mm)	
"R"	Ref. Daniels: AFM8 Ref. Military: M22520/2-01	Ref. order: S/S/1/0060 Ref. Daniels: K547	AWG	26	24	22	4.8÷5.2
			selector No	4	5	3	
"H"	Ref. Daniels: AFM8 Ref. Military: M22520/2-01	Double crimp Core - Ref. Daniels: K547 Jacket - Ref. Daniels: K640				3.9÷4.3	

(*) stripping length

CH SERIES REPLACEMENT CONTACTS

Ref.	Standard socket	Standard pin
B row 1 CHB	15632	15352
B row 1 CHC	15632	15352
B row 2 CHB	15634	15354
B row 2 CHC	15634	15354
B row 3 CHB	-	-
B row 3 CHC	15636	15496
C row 1 CHB	12507	12543
C row 1 CHC	12507	12543
C row 2 CHB	12509	12545
C row 2 CHC	12509	12545
C row 3 CHB	-	-
C row 3 CHC	14072	14074
D	13276	13280
L	12511	12547
R	12512	12548
H	14033	14035
S	12514	12550
Y	12516	12552

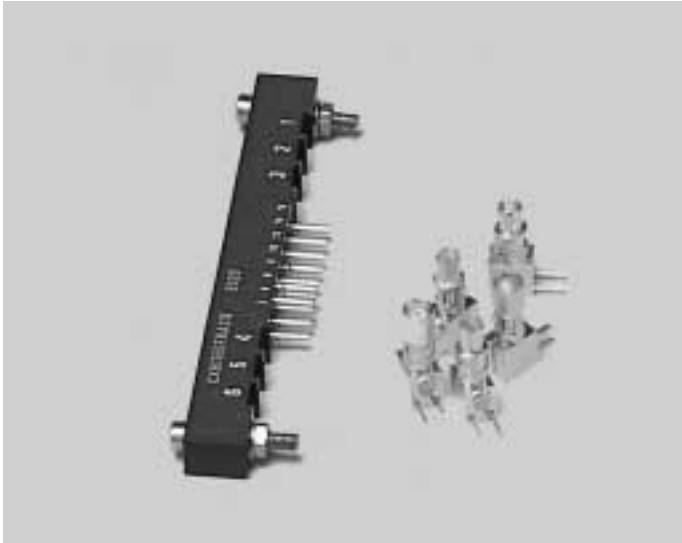

CX are PCB connectors conforming to NF C 93-424 type HE807 and meet general requirements BS9525 and ESA SCC 3401.

The connector series offers the possibility to use signal, power, coax contacts in the same arrangements. Standard contact arrangement is offset grid pattern, two rows within dielectric connector body with 2.54 mm center to center contact spacing in each row and 2.54 mm row-to row spacing. Contact size is 0.6 mm nominal pin DIA.

Coax contact are in agreement with NF-C-93-569, modele KMX3.

Configuration are 17 to 84 standard contact position, and 3 to 8 co-axial or power contact position.

REQUIREMENTS

APPLIED DOCUMENTS

MATERIAL		
Body Contacts	DAP 5553 Brass CuBe	MIL-M-24519 ASTM B16 ASTM B197
Hardware	Phosphor-Bronze Stainless steel CuBe	ASTM B139 ASTM A582 ASTM B196
FINISHES		
Contacts Hardware	Gold Passivation Nichel plated	ASTM B488 ASTM A967 QQ-N-290
MECHANICAL		
Mating/Unmating force Contact life	56g max 100000 insertion	- -
ELECTRICAL		
Current rating ⁽¹⁾ (signal contact) Current rating ⁽¹⁾ (power contact) Contact resistance (signal contact) Contact resistance (power contact) Dielectric withstanding voltage Insulation resistance Impedance (coax contact)	5.0 A 17 A ≤ 10.0 mΩ 1.5 mΩ 1400 VRMS, 60 Hz a.s.l. ≥ 5000 MΩ at 500 VDC 50 Ω	- - - - - - -
PHYSICAL AND ENVIROMENTAL		
Shock Vibration Operating range	- - -65°C +125°C	In accordance with MIL-STD-1344 In accordance with MIL-STD-1344 -

⁽¹⁾ Consult factory for details

How to order

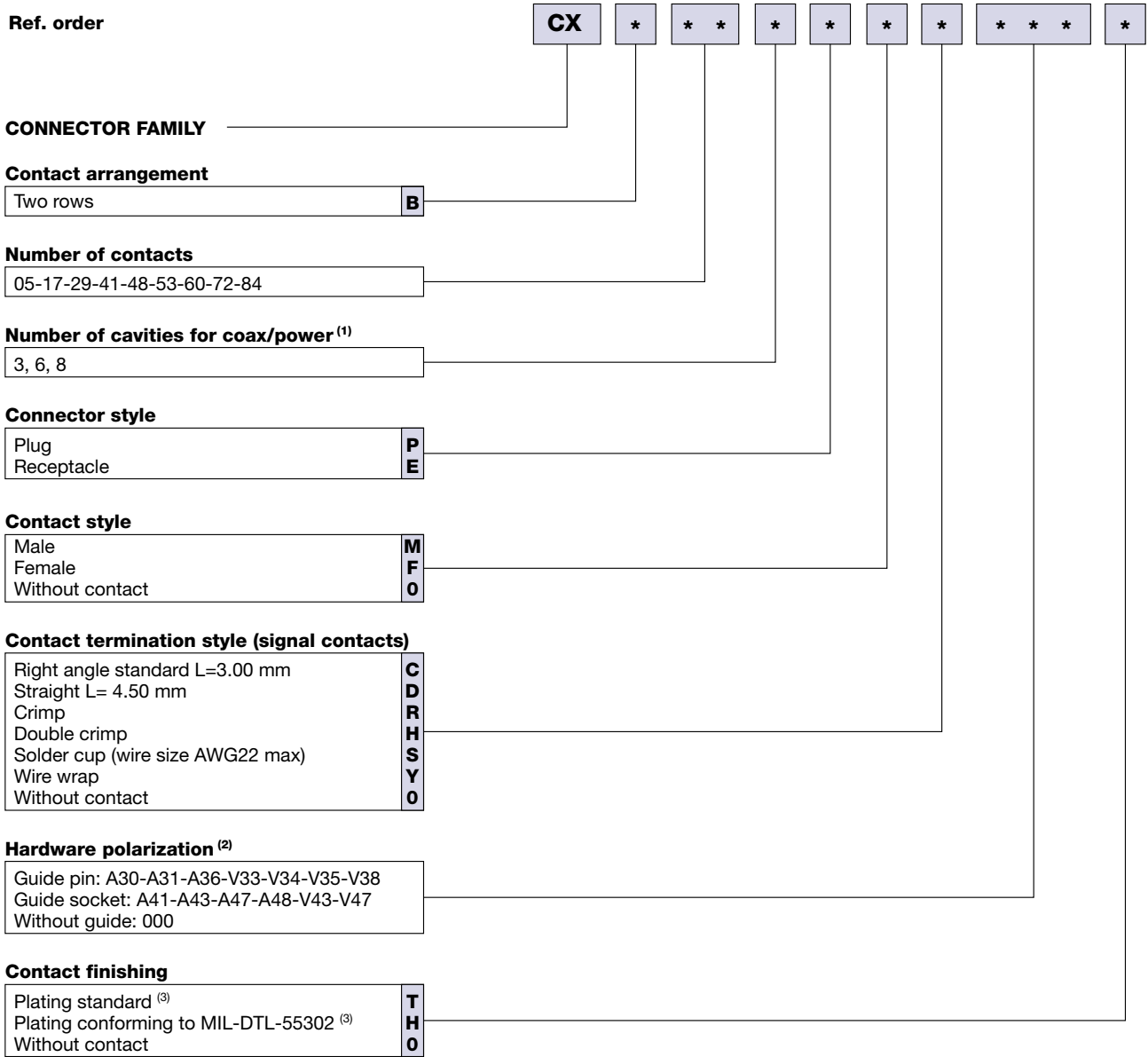

⁽¹⁾ Contacts coax/power must be ordered separately

⁽²⁾ Standard coding: pos. B2

⁽³⁾ **T** Reference:

Functional part (Mating area): 0.25 µm Gold per ASTM B-488 type II Grade C on 2 µm Ni per QQ N-290

Termination area: 0.15 µm Gold per ASTM B-488 type II Grade C on 2 µm Ni per QQ N-290

H Reference:

Functional part (Mating area): 1.27 µm Gold per ASTM B-488 type II Grade C on 2 µm Ni per QQ N-290

Termination area: 0.508 µm Gold per ASTM B-488 type II Grade C on 2 µm Ni per QQ N-290

Connector dimensions CXB053 to CXB533

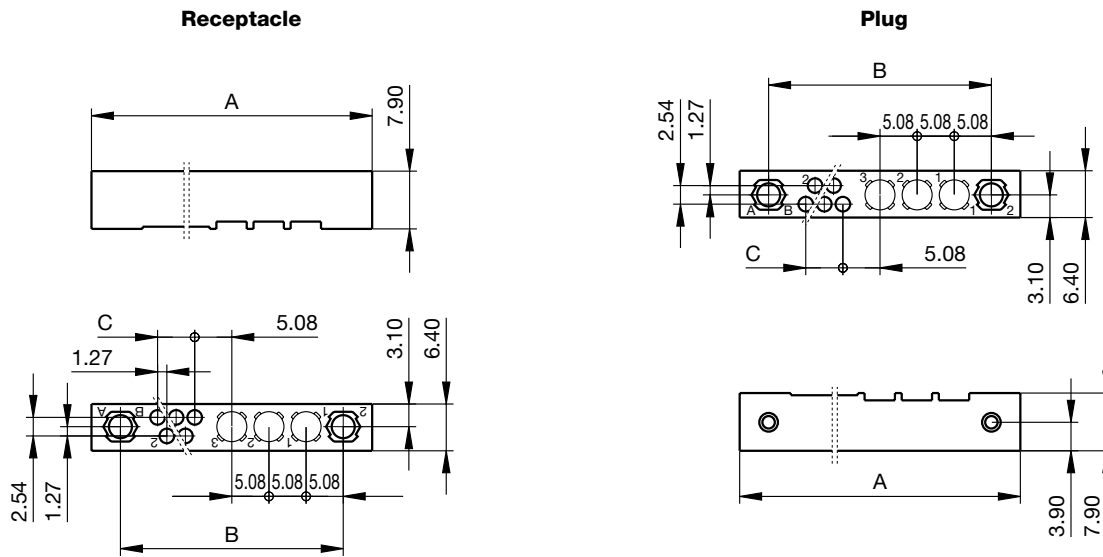

No of contacts	CXB053	CXB173	CXB293	CXB413	CXB533
A	38.40	53.60	68.90	84.10	99.40
B	30.48	45.72	60.96	76.20	91.44
C	5.08	20.32	35.56	50.80	66.04

Connector dimensions CXB603 to CXB843

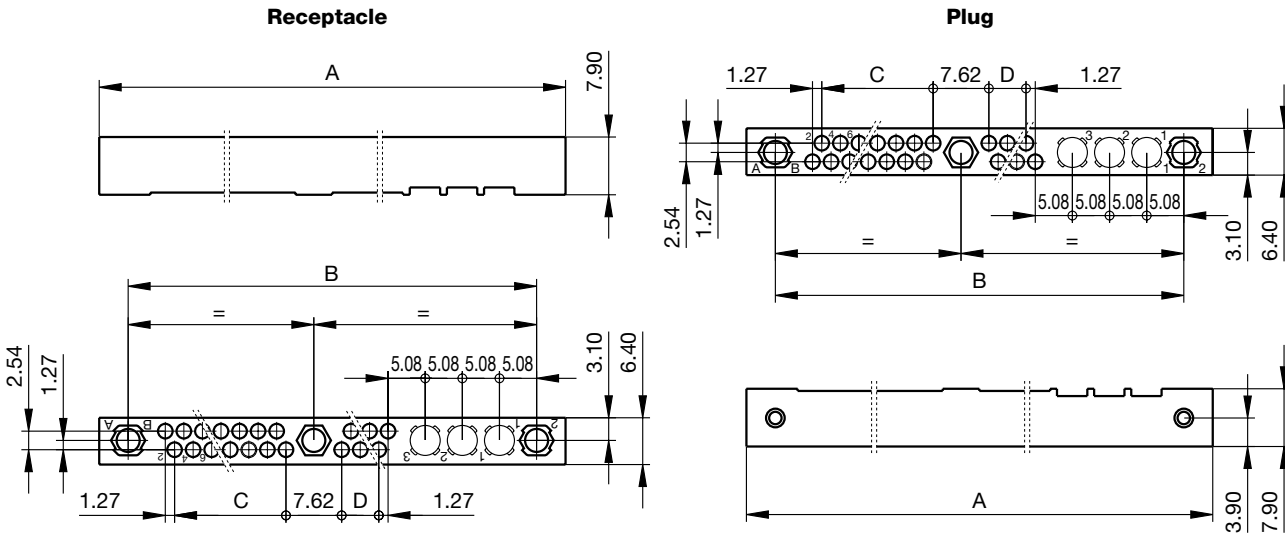

No of contacts	CXB603	CXB723	CXB843
A	114.60	129.80	145.10
B	106.68	121.92	137.16
C	43.18	50.80	58.42
D	27.94	35.56	43.18

Dimensions are in millimeters

Connector dimensions CXB056 to CXB416

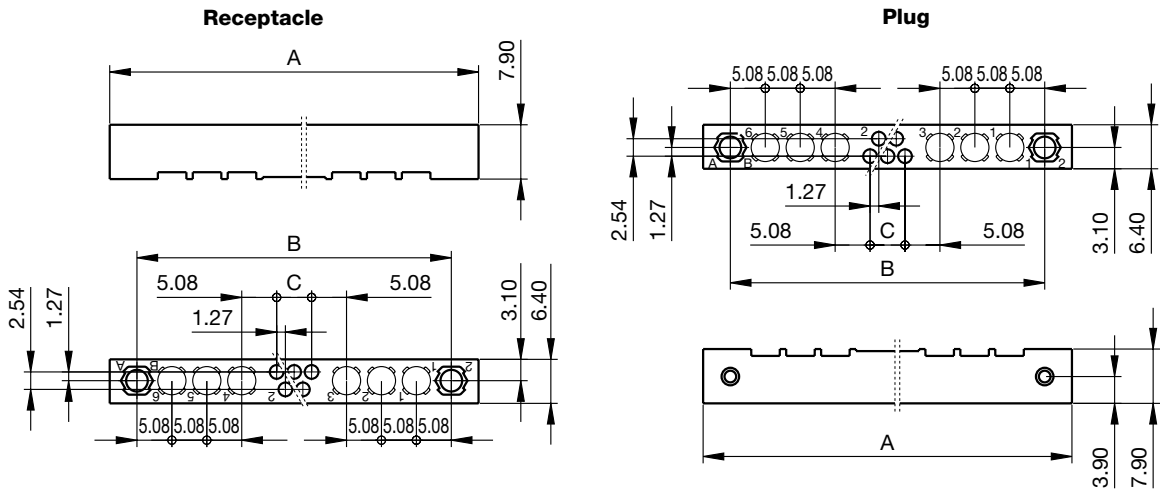

No of contacts	CXB056	CXB176	CXB296	CXB416
A	53.60	68.90	84.10	99.40
B	45.72	60.96	76.20	91.44
C	5.08	20.32	35.56	50.80

Connector dimensions CXB486 to CXB726

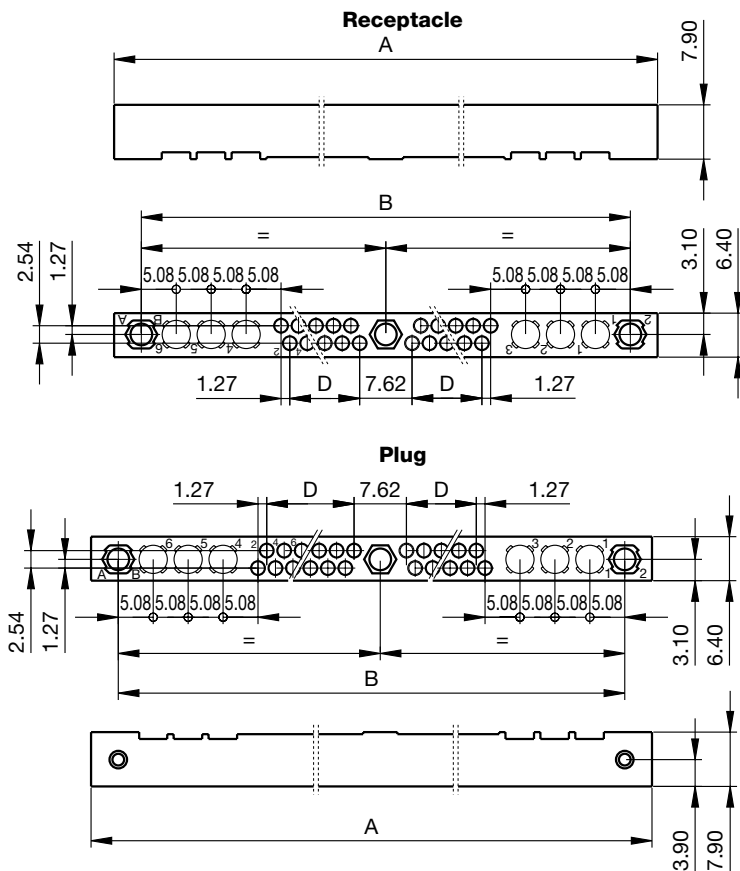

No of contacts	CXB486	CXB606	CXB726
A	114.60	129.80	145.10
B	106.69	121.92	137.16
C	-	-	-
D	27.94	35.56	43.18

Dimensions are in millimeters

Connector dimensions CXB008

Receptacle

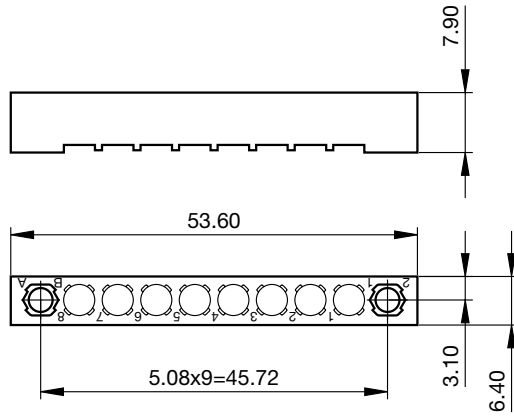

Plug

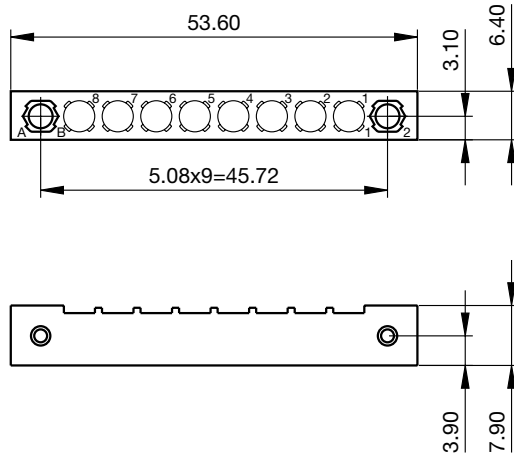

Contact terminal style plug connector

Terminal style	Female	Male
C⁽¹⁾		
D		
R Accept AWG 22, 24, 26	<p>Contacts supplied NOT ASSEMBLED</p>	<p>Contacts supplied NOT ASSEMBLED</p>
H⁽²⁾ Accept AWG 22, 24, 26	<p>Contacts supplied NOT ASSEMBLED</p>	<p>Contacts supplied NOT ASSEMBLED</p>
S Accept up to AWG 22		
Y		

Notes:

- 1) The connector is supplied with positioner to assist the contacts insertion in the PCB
- 2) The connector is supplied with an insulation diaphragm to eliminate the possibility of electric discharge wiring side
- 3) Dimensions are in millimeters

Contact terminal style receptacle connector

Terminal style	Female	Male
C ⁽¹⁾		
D		
R Accept AWG 22, 24, 26	<p>Contacts supplied NOT ASSEMBLED</p>	<p>Contacts supplied NOT ASSEMBLED</p>
H ⁽²⁾ Accept AWG 22, 24, 26	<p>Contacts supplied NOT ASSEMBLED</p>	<p>Contacts supplied NOT ASSEMBLED</p>
S Accept up to AWG 22		
Y		

Notes:

- 1) The connector is supplied with positioner to assist the contacts insertion in the PCB
- 2) The connector is supplied with an insulation diaphragm to eliminate the possibility of electric discharge wiring side
- 3) Dimensions are in millimeters

Coax contacts

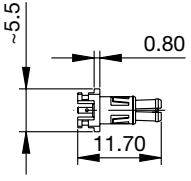
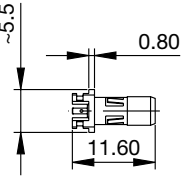
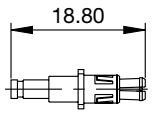
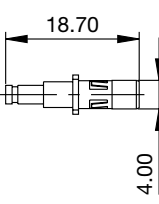
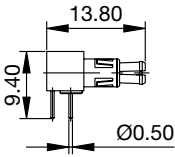
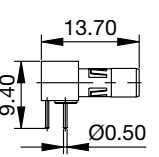
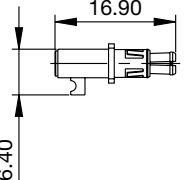
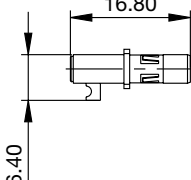
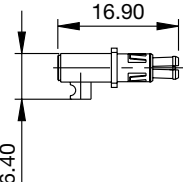
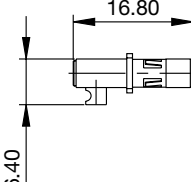
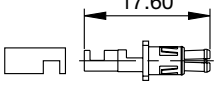
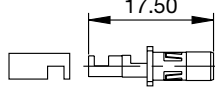
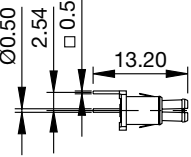
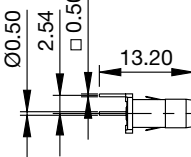
MALE	DESCRIPTION	FEMALE
 <p>~5.5 0.80 11.70</p>	<p>Ref. order: CXM011</p> <p>Male and female contact with solder termination Assembling scheme see page 53</p> <p>Ref. order: CXF011</p>	 <p>~5.5 0.80 11.60</p>
 <p>18.80</p>	<p>Ref. order: CXM021</p> <p>Male and female contact with solder termination suitable for flexible cable Øest. 2.00 mm Ref. KX 21 A/RG 196 AU Assembling scheme see page 53</p> <p>Ref. order : CXF021</p>	 <p>18.70 4.00</p>
 <p>13.80 9.40 Ø0.50</p>	<p>Ref. order: CXM032</p> <p>Male and female contact with solder termination right angle</p> <p>Ref. order: CXF032</p>	 <p>13.70 9.40 Ø0.50</p>
 <p>16.90 6.40</p>	<p>Ref. order: CXM012</p> <p>Male and female contact with solder termination, 90° cable entry, suitable for flexible cable Øest. 2.00 mm ref. KX 21 A/RG 196 AU Assembling scheme see page 53</p> <p>Ref. order : CXF012</p>	 <p>16.80 6.40</p>
 <p>16.90 6.40</p>	<p>Ref. order: CXM052</p> <p>Male and female contact with solder termination, 90° cable entry, suitable for semi-rigid cable Øest. 2.16 mm ref. KS 1/RG 405 U Assembling scheme see page 53</p> <p>Ref. order : CXF052</p>	 <p>16.80 6.40</p>
 <p>17.60</p>	<p>Ref. order: CXM061</p> <p>Male and female contact with solder termination suitable for semi-rigid cable Øest. 2.16 mm ref. KS 1/RG 405 U Assembling scheme see page 53</p> <p>Ref. order : CXF061</p>	 <p>17.50</p>
 <p>Ø0.50 2.54 □ 0.50 13.20</p>	<p>Ref. order: CXM041</p> <p>Male and female with straight p.c.b. termination (p.c.b. thickness 3.2 max)</p> <p>Ref. order : CXF041</p>	 <p>Ø0.50 2.54 □ 0.50 13.20</p>

Notes:
 1) Contacts must be ordered separately
 2) Contacts are supplied NOT ASSEMBLED
 3) Dimensions are in millimeters

Power contact (10 A)

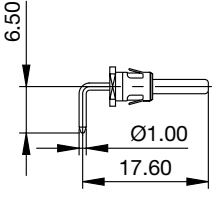
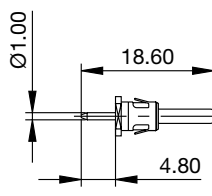
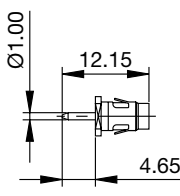
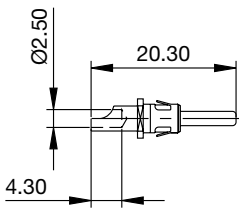
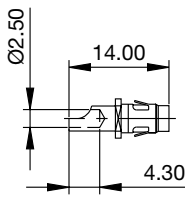
MALE	DESCRIPTION	FEMALE
	<p>Ref. order: CXM332</p> <p>Male contact with solder termination right angle</p>	
	<p>Ref. order: CXM341</p> <p>Male and female with straight p.c.b. termination</p> <p>Ref. order : CXF341</p>	
	<p>Ref. order: CXM321</p> <p>Male and female power contact with solder termination</p> <p>Ref. order: CXF321</p>	

Notes:
 1) Contacts must be ordered separately
 2) Contacts are supplied NOT ASSEMBLED
 3) Dimensions are in millimeters

Codify hardware

Ref.	For connector	Lateral fixing	Central fixing
A30	PLUG		
A31	PLUG RECEPTACLE		
A41	PLUG RECEPTACLE		
A47	PLUG RECEPTACLE		

Notes
 1) 0.10 N*m (1.1 Kg*cm) torque
 2) 0.24 N*m (2.5 Kg*cm) torque
 3) Dimensions are in millimeters

Hardware for test connector

Ref.	For connector	Lateral and central fixing
A36	PLUG	
A48	RECEPTACLE	

Floating hardware

Ref.	For connector	Lateral fixing	Central fixing
A43	PLUG RECEPTACLE		

- Notes
 1) 0.10 N*m (1.1 Kg*cm) torque
 2) 0.24 N*m (2.5 Kg*cm) torque
 3) Dimensions are in millimeters

Screw locking hardware

Ref.	For connector	Lateral fixing	Central fixing
V33	PLUG RECEPTACLE		
V34	PLUG		
V35	PLUG RECEPTACLE		
V38	PLUG		
V43	PLUG RECEPTACLE		
V47	PLUG RECEPTACLE		

Notes
 1) 0.10 N*m (1.1 Kg*cm) torque
 2) 0.24 N*m (2.5 Kg*cm) torque
 3) Dimensions are in millimeters

Compatibility between fixings

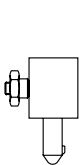
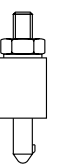
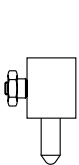
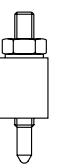
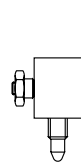
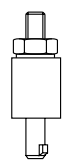
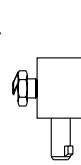
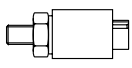
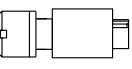
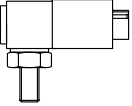
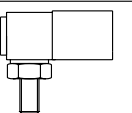
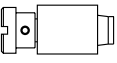
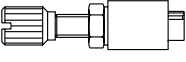
		 for plug	 for plug/receptacle	 for plug	 for plug/receptacle	 for plug	 for plug/receptacle	 for plug
		A30	A31	A36	V33	V34	V35	V38
 for plug/receptacle	A41	*	*	*				
 for plug/receptacle	A43	*	*	*				
 for plug/ receptacle	A47	*	*	*				
 for plug/receptacle	A48	*	*	*				
 for plug/receptacle	V43				*	*		
 for plug/receptacle	V47						*	*

Mounting pattern for connectors with three coax contact ref. CXF032 - CXM032

Mounting pattern for receptacle connector with two fixing type: A47, A48 (view component side)

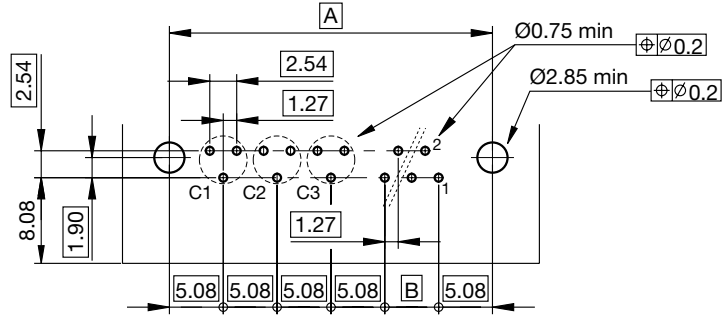

Mounting pattern for receptacle connector with three fixing type: A47, A48 (view component side)

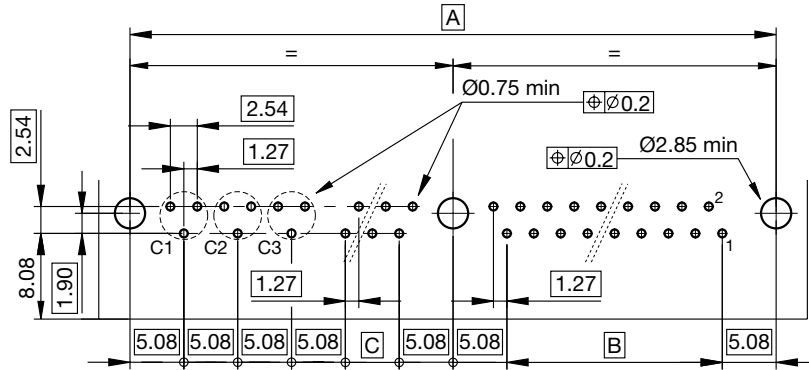

Mounting pattern for plug connector with two fixing type: A30, A36, V34, V38 (view component side)

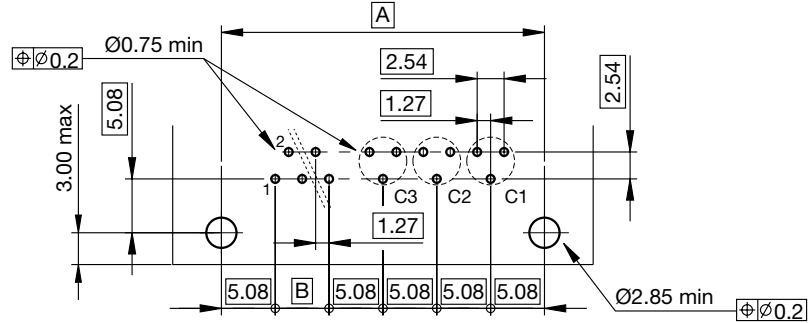

Mounting pattern for plug connector with three fixing type: A30, A36, V34, V38 (view component side)

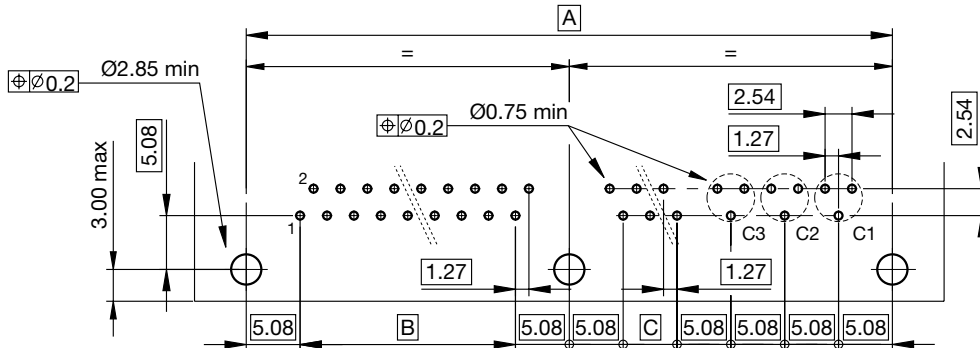

Size No contact standard/coax	17 (5+3)	29 (17+3)	41 (29+3)	53 (41+3)	65 (53+3)	72 (60+3)	84 (72+3)	96 (84+3)
A	30.48	45.72	60.96	76.20	91.44	106.68	121.92	137.16
B	5.08	20.32	35.56	50.80	66.04	43.18	50.80	58.42
C	-	-	-	-	-	27.94	35.56	43.18

Dimensions are in millimeters

Mounting pattern for connectors with six coax contact ref. CXF032 - CXM032

Mounting pattern for receptacle connector with two fixing type: A47, A48 (view component side)

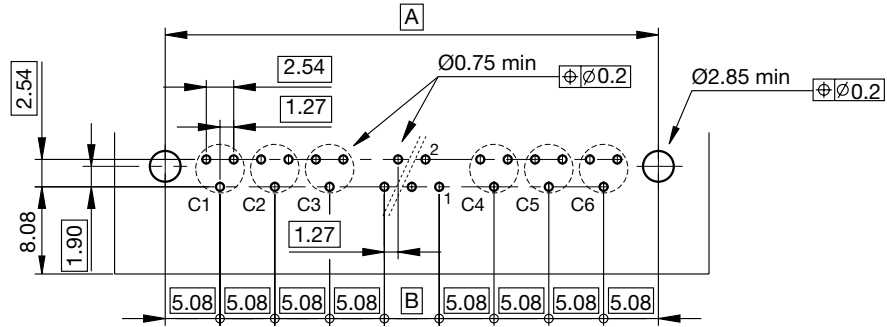

Mounting pattern for receptacle connector with three fixing type: A47, A48 (view component side)

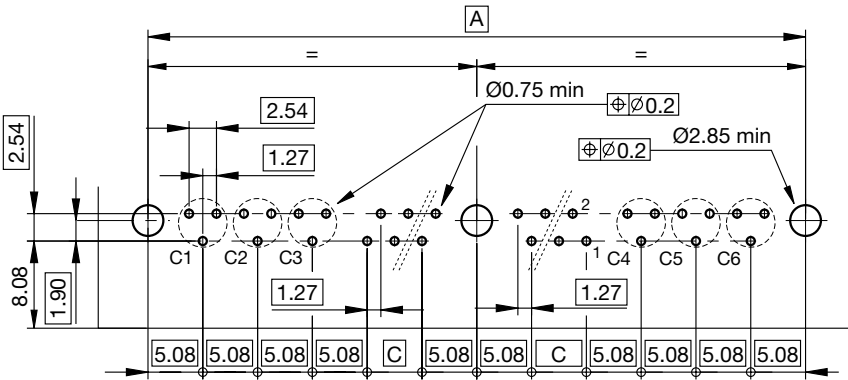

Mounting pattern for plug connector with two fixing type: A30, A36, V34, V38 (view component side)

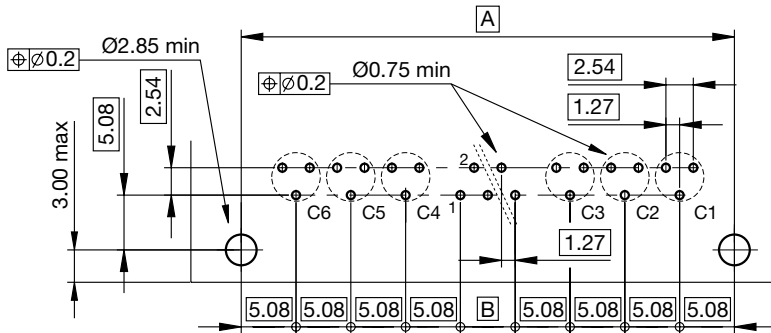

Mounting pattern for plug connector with three fixing type: A30, A36, V34, V38 (view component side)

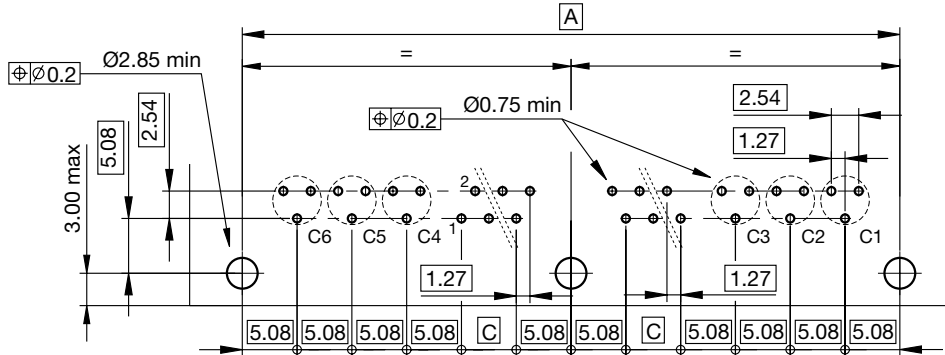

Size No contact standard/coax	17	29 (5+6)	41 (17+6)	53 (29+6)	65 (41+6)	72 (48+6)	84 (60+6)	96 (72+6)
A	-	45.72	60.96	76.20	91.44	106.68	121.92	137.16
B	-	5.08	20.32	35.56	50.80	-	-	-
C	-	-	-	-	-	27.94	35.56	43.18

Dimensions are in millimeters

Mounting pattern for connectors with three coax contact ref. CXF041 - CXM041

Mounting pattern for receptacle connector with two fixing type: A41, A31, V33, V35 (view component side)

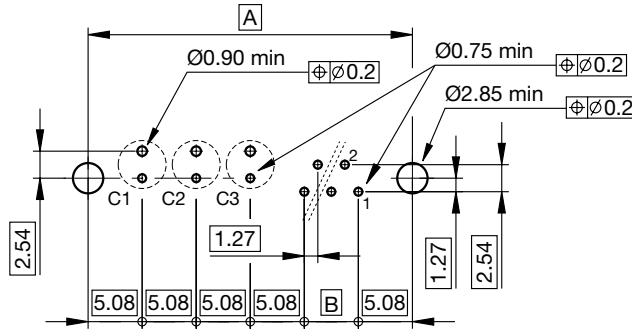

Mounting pattern for receptacle connector with three fixing type: A41, A31, V33, V35 (view component side)

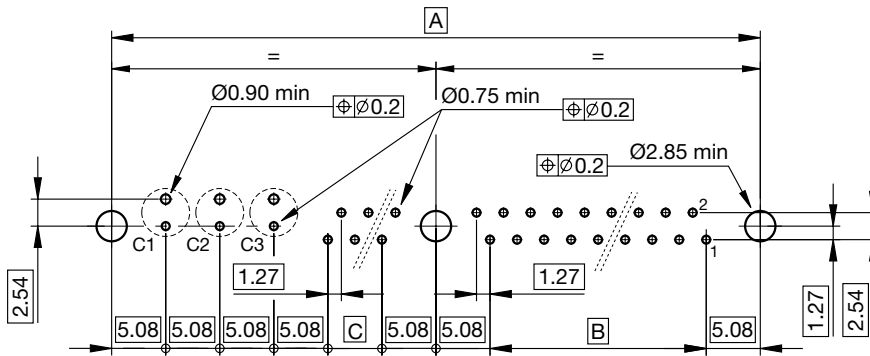

Mounting pattern for plug connector with two fixing type: A41, A31, V33, V35 (view component side)

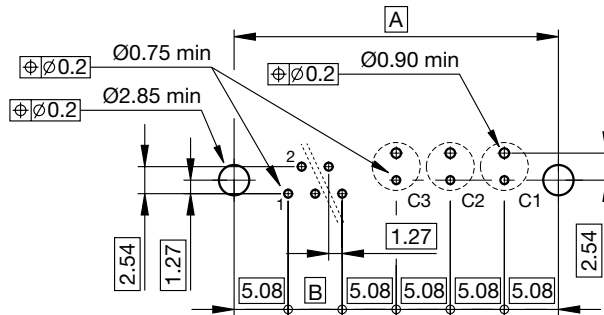

Mounting pattern for plug connector with three fixing type: A41, A31, V33, V35 (view component side)

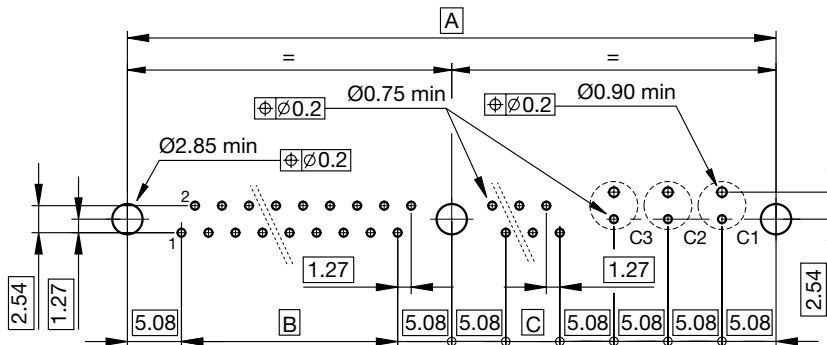

Size No contact standard/coax	17 (5+3)	29 (17+3)	41 (29+3)	53 (41+3)	65 (53+3)	72 (60+3)	84 (72+3)	96 (84+3)
A	30.48	45.72	60.96	76.20	91.44	106.68	121.92	137.16
B	5.08	20.32	35.56	50.80	66.04	43.18	50.80	58.42
C	-	-	-	-	-	27.94	35.56	43.18

Dimensions are in millimeters

Mounting pattern for connectors with six coax contact ref. CXF041 - CXM041

Mounting pattern for receptacle connector with two fixing type: A41, A31, V33, V35 (view component side)

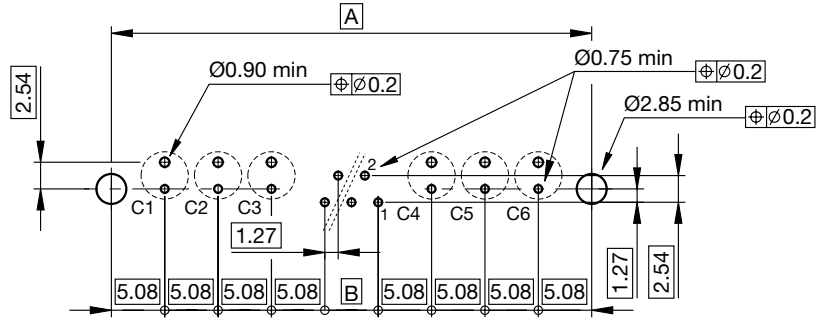

Mounting pattern for receptacle connector with three fixing type: A41, A31, V33, V35 (view component side)

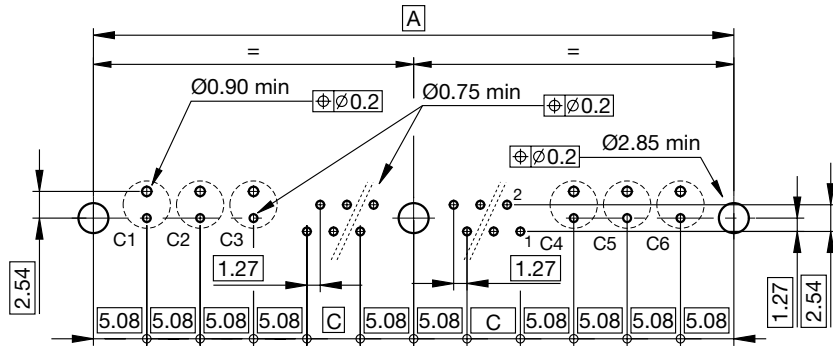

Mounting pattern for plug connector with two fixing type: A41, A31, V33, V35 (view component side)

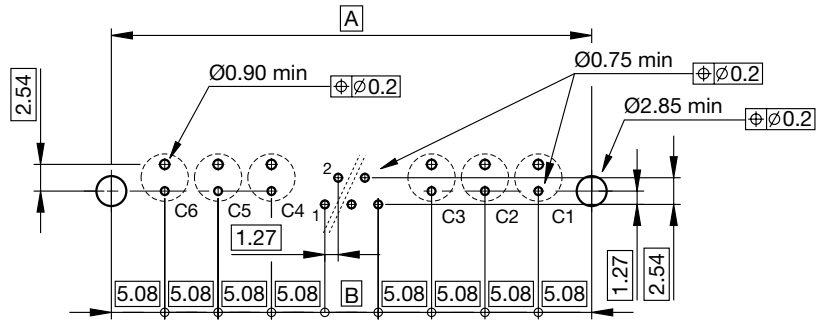

Mounting pattern for plug connector with three fixing type: A30, A36, V34, V38 (view component side)

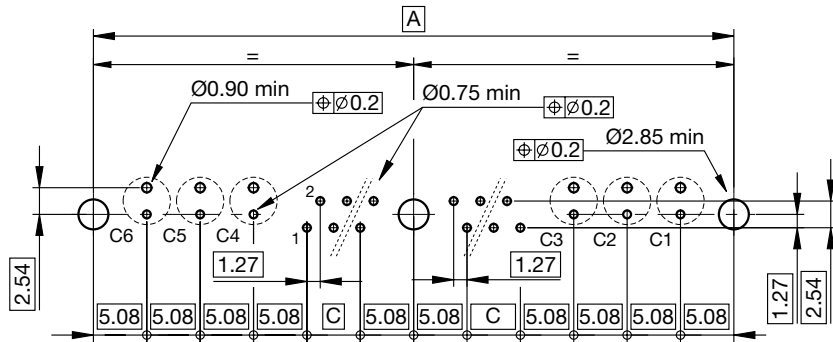

Size	17	29 (5+6)	41 (17+6)	53 (29+6)	65 (41+6)	72 (48+6)	84 (60+6)	96 (72+6)
No contact standard/coax								
A	-	45.72	60.96	76.20	91.44	106.68	121.92	137.16
B	-	5.08	20.32	35.56	50.80	-	-	-
C	-	-	-	-	-	27.94	35.56	43.18

Dimensions are in millimeters

Mounting pattern for connectors with eight coax contact

Mounting pattern for receptacle connector with two fixing type A41, A31, V33, V35 and coax contact type CXF041, CXM041 (view component side)

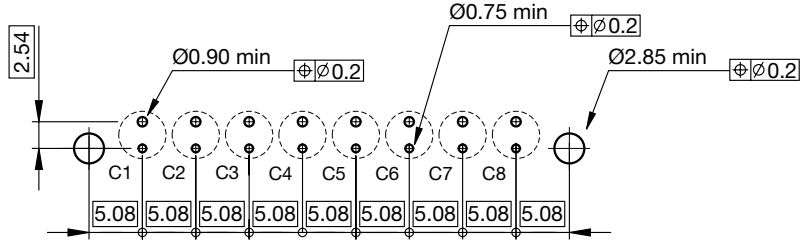

Mounting pattern for plug connector with two fixing type A41, A31, V33, V35 and coax contact type CXF041, CXM041 (view component side)

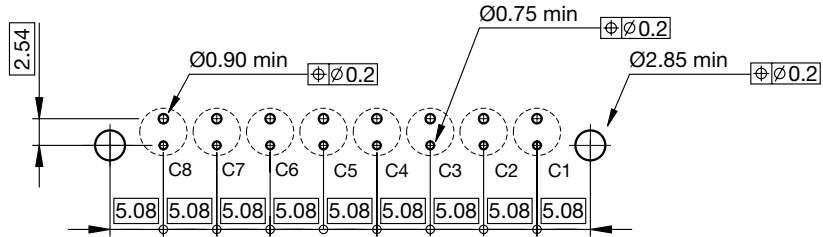

Mounting pattern for receptacle connector with two fixing type A47, A48 and coax contact type CXF032, CXM032 (view component side)

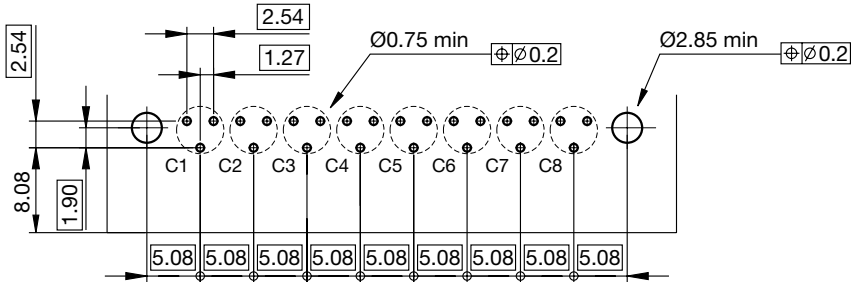

Mounting pattern for plug connector with two fixing type A30, A36, V34, V38 coax contact type CXF032, CXM032 (view component side)

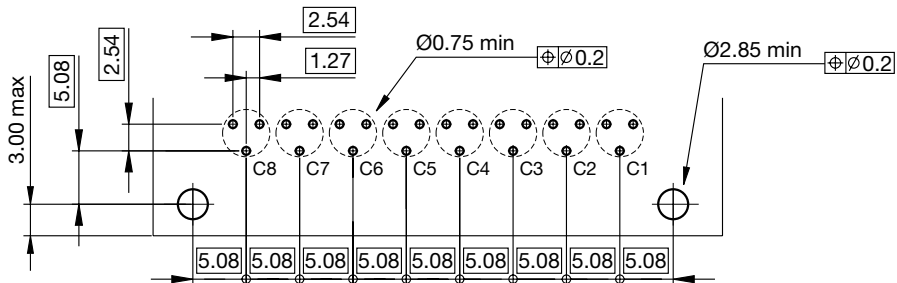

Dimensions are in millimeters

Mounting pattern for connectors with three power contact ref. CXF341 - CXM341

Mounting pattern for receptacle connector with two fixing type: A41, A31, V33, V35 (view component side)

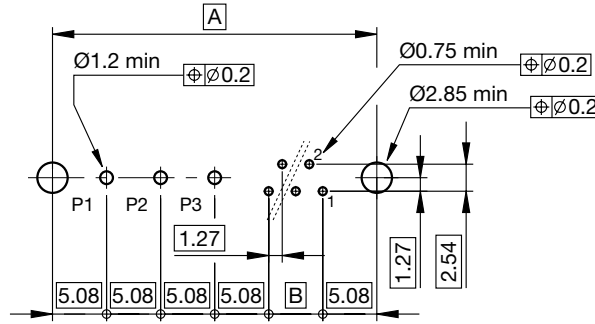

Mounting pattern for receptacle connector with three fixing type: A41, A31, V33, V35 (view component side)

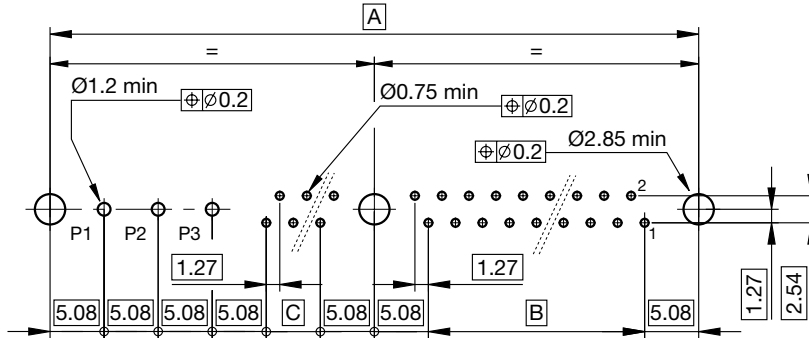

Mounting pattern for plug connector with two fixing type: A41, A31, V33, V35 (view component side)

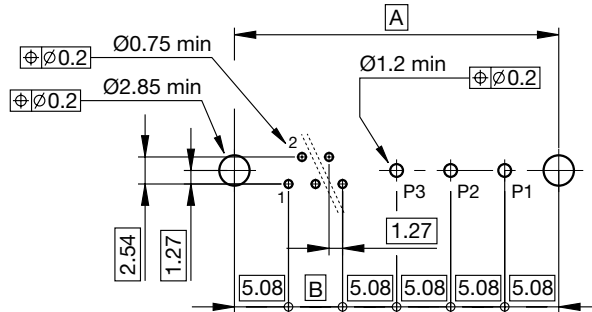

Mounting pattern for plug connector with three fixing type: A41, A31, V33, V35 (view component side)

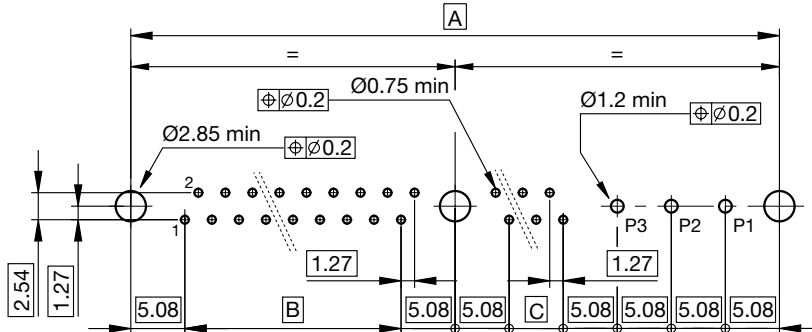

Size No contact standard/coax	17 (5+3)	29 (17+3)	41 (29+3)	53 (41+3)	65 (53+3)	72 (60+3)	84 (72+3)	96 (84+3)
A	30.48	45.72	60.96	76.20	91.44	106.68	121.92	137.16
B	5.08	20.32	35.56	50.80	66.04	43.18	50.80	58.42
C	-	-	-	-	-	27.94	35.56	43.18

Dimensions are in millimeters

Mounting pattern for connectors with six power contact ref. CXF341 - CXM341

Mounting pattern for receptacle connector with two fixing type: A41, A31, V33, V35 (view component side)

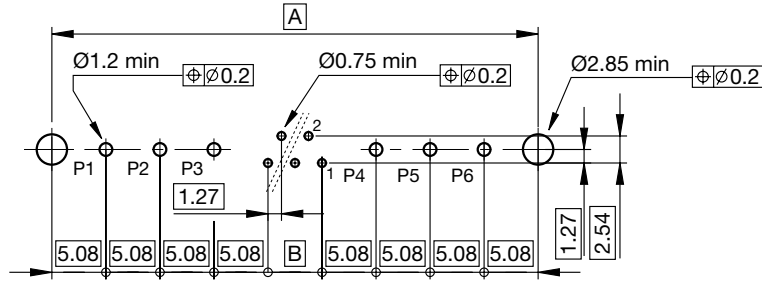

Mounting pattern for receptacle connector with three fixing type: A41, A31, V33, V35 (view component side)

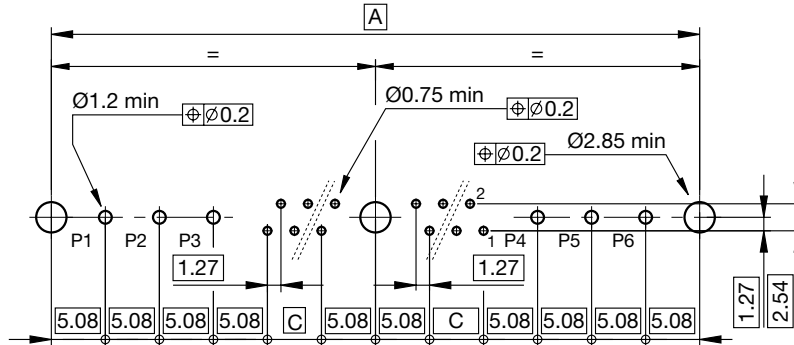

Mounting pattern for plug connector with two fixing type: A41, A31, V33, V35 (view component side)

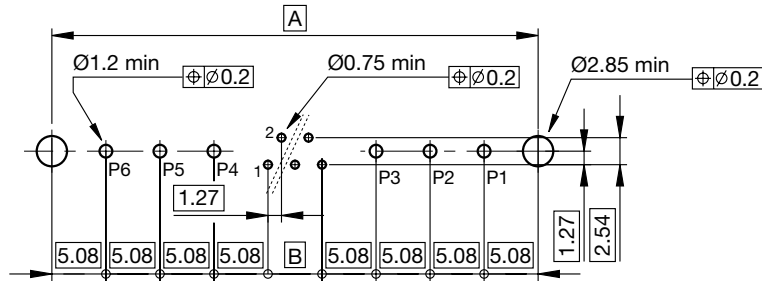

Mounting pattern for plug connector with three fixing type: A30, A36, V34, V38 (view component side)

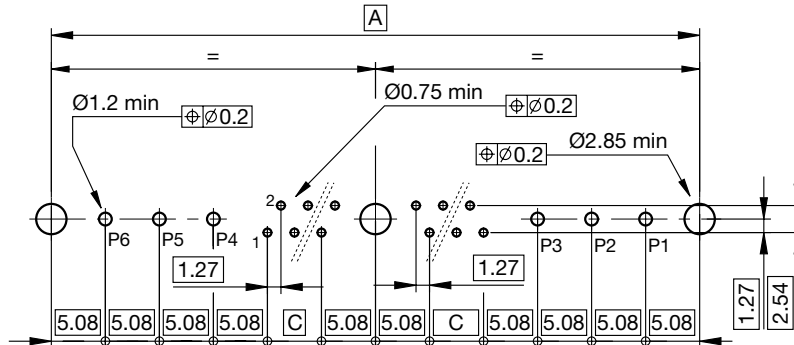

Size No contact standard/coax	17	29 (5+6)	41 (17+6)	53 (29+6)	65 (41+6)	72 (48+6)	84 (60+6)	96 (72+6)
A	-	45.72	60.96	76.20	91.44	106.68	121.92	137.16
B	-	5.08	20.32	35.56	50.80	-	-	-
C	-	-	-	-	-	27.94	35.56	43.18

Dimensions are in millimeters

Mounting pattern for connectors with eight power contact ref. CXF341 - CXM341

Mounting pattern for receptacle connector with two fixing type: A41, A31, V33, V35 (view component side)

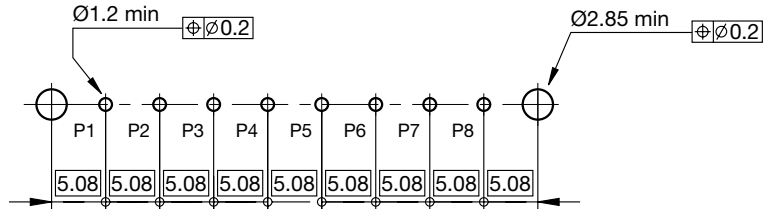

Mounting pattern for plug connector with two fixing type: A41, A31, V33, V35 (view component side)

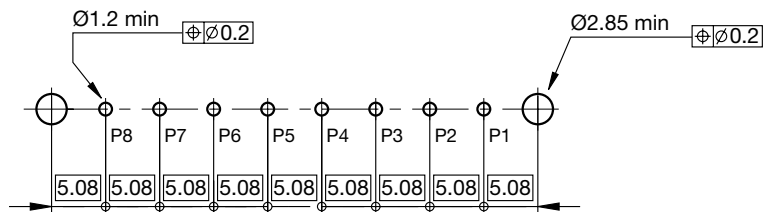

Mounting pattern for connectors with three or six power contact ref. CXF332 - CXM332

Mounting pattern for plug connector with three power contact and two fixing type: A30, A36, V34, V38 (view component side)

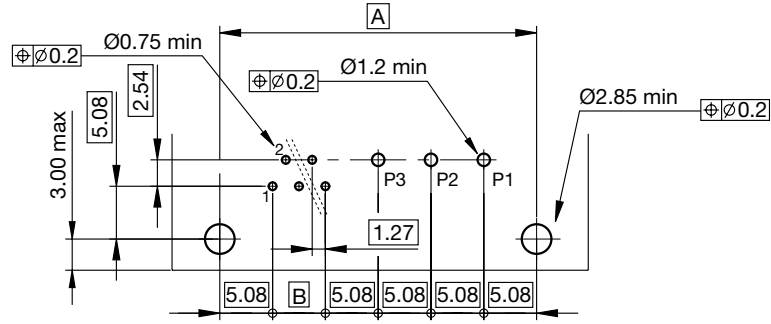

Mounting pattern for plug connector with three power contact and three fixing type: A30, A36, V34, V38 (view component side)

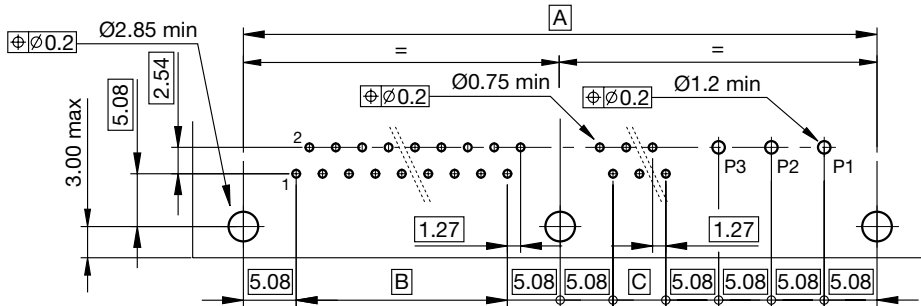

Size No contact standard/coax	17 (5+3)	29 (17+3)	41 (29+3)	53 (41+3)	65 (53+3)	72 (60+3)	84 (72+3)	96 (84+3)
A	30.48	45.72	60.96	76.20	91.44	106.68	121.92	137.16
B	5.08	20.32	35.56	50.80	66.04	43.18	50.80	58.42
C	-	-	-	-	-	27.94	35.56	43.18

Mounting pattern for plug connector with six power contact and two fixing type: A30, A36, V34, V38 (view component side)

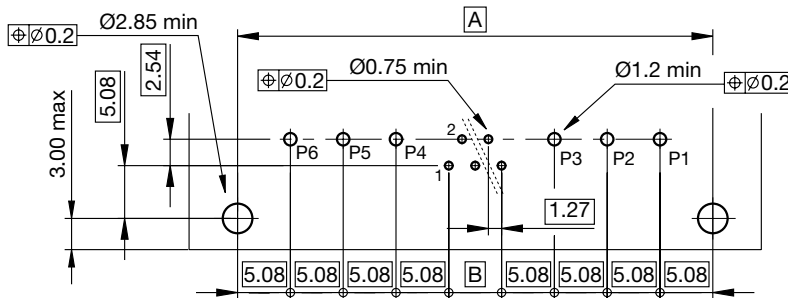

Mounting pattern for plug connector with six power contact and three fixing type: A30, A36, V34, V38 (view component side)

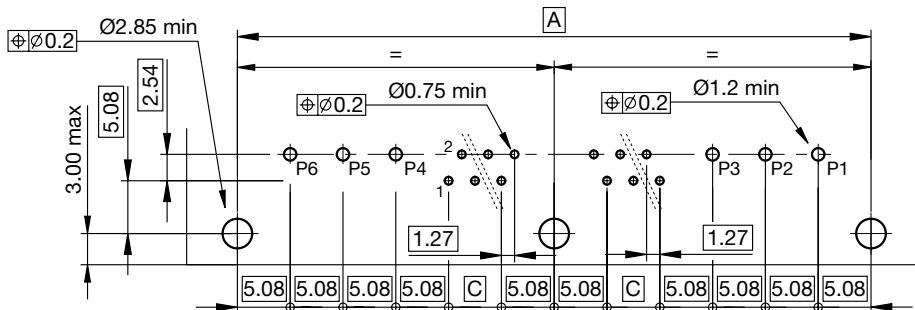

Size No contact standard/coax	17	29 (5+6)	41 (17+6)	53 (29+6)	65 (41+6)	72 (48+6)	84 (60+6)	96 (72+6)
A	-	45.72	60.96	76.20	91.44	106.68	121.92	137.16
B	-	5.08	20.32	35.56	50.80	-	-	-
C	-	-	-	-	-	27.94	35.56	43.18

Dimensions are in millimeters

Panel cut-out

Panel cut-out for fixing hardware, without central fixing

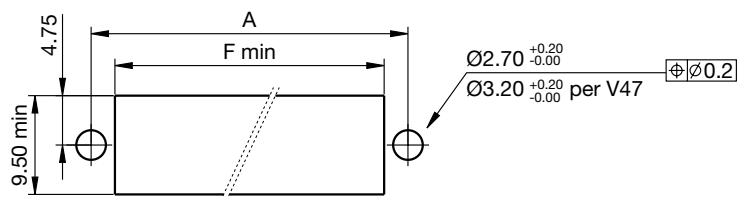

Panel cut-out for fixing hardware, with central fixing

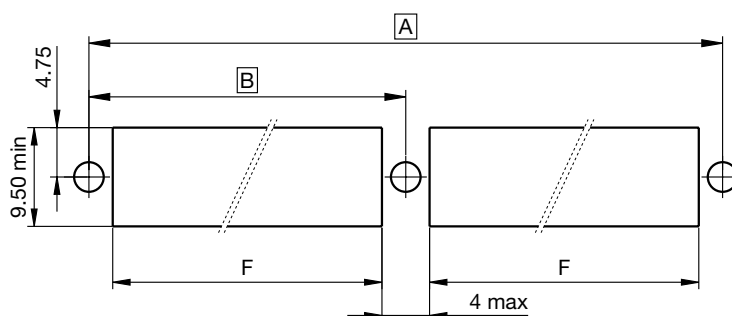

Panel cut-out for floating hardware

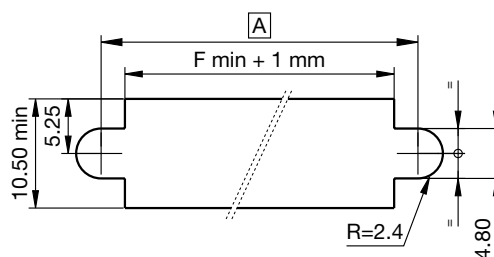

Size	17	29	41	53	65	72	84	96
A	30.48	45.72	60.96	76.20	91.44	106.68	121.92	137.16
B	-	-	-	-	-	53.34	60.96	68.58
F min	25.90	41.10	56.40	71.60	86.90	48.50	56.00	63.60

Tools

Extraction tool S/DEM/6/0060

Insertion tool S/MONT/1/0060

Extraction tool for coax and power contact 1_2634

Tool for wire-wrap connection Consult factory

NOTES FOR WIRE-WRAP CONNECTION

AWG	Ø cable (mm)	No coil	L* (mm)
30	0.25	8	25
28	0.32	7	23
26	0.4	6	23

(*) stripping length

CRIMP TOOL

Contact type	Crimp tool	Crimp positioner	Crimp setup				L* (mm)
			AWG	26	24	22	
"R"	Ref. Daniels: AFM8 Ref. Military: M22520/2-01	Ref. order: S/S/1/0060 Ref. Daniels: K547	AWG	26	24	22	4.8÷5.2
			selector No	4	5	3	
"H"	Ref. Daniels: AFM8 Ref. Military: M22520/2-01	Double crimp Core - Ref. Daniels: K547 Jacket - Ref. Daniels: K640					3.9÷4.3

(*) stripping length

CX SERIES REPLACEMENT CONTACTS

Ref.	Standard socket	Standard pin
C row 1 CHB	12507	12543
C row 2 CHC	12509	12545
D	13276	13280
R	12512	12548
H	14033	14035
S	12514	12550
Y	12516	12552

Assembling scheme for coax contact

<p>Coax Contacts ref. CXF011 and CXM011</p> <ol style="list-style-type: none"> 1) Strip the cable as per ref. A 2) Solder the inner conductor of the cable on the central contact of the coax (1) 3) Solder the external braid of the cable on the external body of the coax (2) 	<p>The diagram shows a cable with length 'A' being prepared. Step 1 shows the inner conductor being inserted into the central contact (1). Step 2 shows the external braid being soldered to the external body of the contact (2). Labels 'Solder' indicate the application of solder at both connection points.</p>
<p>Coax Contacts ref. CXF021 and CXM021</p> <ol style="list-style-type: none"> 1) Strip the cable as per ref. A 2) Insert the heat shrinkable protection (4) and the external sleeve (3) on the cable 3) Prepare the inner conductor of the cable using a Sn/Pb Solder (pretinning) and insert it in the central contact (1) wrapping the external braid of the cable on the external body of the contact (2) 4) Solder the inner contact of the cable on the central contact (1) 5) Slip the sleeve (3) on the external braid 6) Solder the external sleeve (3) on the braid of the cable wrapped around the external body of the contact (2) 7) Slip on the heat shrinkable protection (4) and heat it on the external sleeve (3) and cable. 	<p>The diagram illustrates a multi-step assembly. Step 1 shows the inner conductor inserted into the central contact (1). Step 2 shows the external braid wrapped around the external body of the contact (2). Step 3 shows the inner contact being soldered to the central contact (1). Step 4 shows the sleeve (3) being slipped on the external braid. Step 5 shows the sleeve (3) being soldered to the braid. Step 6 shows the heat shrinkable protection (4) being slipped on the sleeve (3) and heated. Labels 'Solder' indicate the application of solder at the inner contact and sleeve connections.</p>
<p>Coax Contacts ref. CXF012 and CXM012</p> <ol style="list-style-type: none"> 1) Strip the cable as per ref. A 2) Insert the heat shrinkable protection (3) on the cable 3) Prepare the inner conductor of the cable using a Sn/Pb Solder (pretinning) , insert it in the central contact (1) and solder 4) Wrap the external braid of the cable on the external body of the contact (2) soldering it 5) Close the bottom of the contact with the spacer (4) and the cover (5) 5) Slip on the heat shrinkable protection (4) and heat on the external sleeve (3) and cable. 	<p>The diagram shows the cable being prepared with heat shrinkable protection (3). Step 1 shows the inner conductor inserted into the central contact (1). Step 2 shows the external braid wrapped around the external body of the contact (2). Step 3 shows the inner contact being soldered to the central contact (1). Step 4 shows the bottom of the contact being closed with the spacer (4) and the cover (5). Step 5 shows the heat shrinkable protection (3) being slipped on and heated. Labels 'Solder' indicate the application of solder at the inner contact and braid connections.</p>
<p>Coax Contacts ref. CXF061 and CXM061</p> <ol style="list-style-type: none"> 1) Strip the cable as per ref. A 2) Insert the heat shrinkable protection (4) and the external sleeve (3) on the cable 3) Prepare the inner conductor of the cable using a Sn/Pb Solder (pretinning) and insert it in the central contact (1) 4) Solder the inner contact of the cable on the central contact (1) 5) Slip the sleeve (3) on the bottom of the body and solder together, braid of the cable, sleeve (3) and body of the contact (2) 6) Slip on the heat shrinkable protection (4) and heat it on the external sleeve (3) and cable. 	<p>The diagram shows the cable being prepared with heat shrinkable protection (4) and an external sleeve (3). Step 1 shows the inner conductor inserted into the central contact (1). Step 2 shows the external braid wrapped around the external body of the contact (2). Step 3 shows the inner contact being soldered to the central contact (1). Step 4 shows the sleeve (3) being slipped on the bottom of the body and soldered together with the braid of the cable and the body of the contact (2). Step 5 shows the heat shrinkable protection (4) being slipped on and heated. Labels 'Solder' indicate the application of solder at the inner contact and sleeve connections.</p>
<p>Coax Contacts ref. CXF052 and CXM052</p> <ol style="list-style-type: none"> 1) Strip the cable as per ref. A 2) Insert the heat shrinkable protection (3) on the cable 3) Prepare the inner conductor of the cable using a Sn/Pb Solder (pretinning) and insert it in the central contact (1) . 4) Wrap the external braid of the cable on the external body of the contact (2) and solder it. 5) Solder the inner contact (1). 6) Close the bottom of the contact with the spacer (4) and the cover (5) 7) Slip on the heat shrinkable protection (4) and heat on the external sleeve (3) and cable. 	<p>The diagram shows the cable being prepared with heat shrinkable protection (3). Step 1 shows the inner conductor inserted into the central contact (1). Step 2 shows the external braid wrapped around the external body of the contact (2). Step 3 shows the inner contact being soldered to the central contact (1). Step 4 shows the bottom of the contact being closed with the spacer (4) and the cover (5). Step 5 shows the heat shrinkable protection (3) being slipped on and heated. Labels 'Solder' indicate the application of solder at the inner contact and braid connections.</p>

OTHER PRODUCTS FROM HYPERTAC

2 TO 5 ROWS PCB CONNECTORS

- . According to MIL-DTL-55302
- . 100 000 reliable mating and unmating cycles
- . Reduces need for board stiffeners and auxiliary actuators
- . Virtual immunity to shock and vibration
- . Under 5 mΩ contact resistance

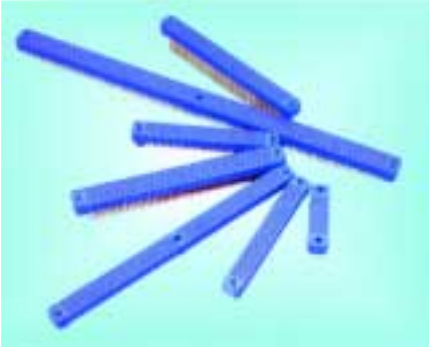

VERY HIGH DENSITY PCB CONNECTOR

- . According to MIL-DTL-55302
- . 8 row offset grid (2,54 mm contacts, 1,27 mm rows)
- . 372 contacts
- . Lightweight with high structural strength
- . Low insertion force



SIGNAL/POWER & COAXIAL CONTACTS

- Signal & power contacts
 - . Over 100 000 mating and unmating cycles
 - . Models for dry circuit to 500 Amps
 - . Ideal for test, burn-in and high power use
- Coaxial contacts
 - . Suits DIN 41612 cavity
 - . Over 25 000 mating cycles
 - . Low insertion force (140 grams average)



METAL SHELLLED PCB CONNECTORS

- . According to MIL-DTL-55302
- . ESD insulation, EMI & RFI protection
- . Easily tailored to customer specific requirements
- . Suitable for LRM applications
- . Available as test connector, card extender and cable assembly



MIL-DTL-55302 PCB CONNECTORS

- . 2 contact rows within dielectric connector
- . Contact size of 0.76 mm nominal pin diameter
- . Number of contacts: 10-14-20-24-26-30-36-44-50-54-59-176
- . Alignment and keying provided by the end guide

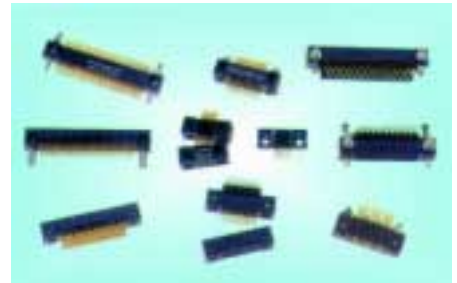

AIRFRAME H71 SERIES

- . Meets performance requirements of BAe spec JN1123
- . Outstanding performance under extreme vibration conditions
- . Jackscrew mating device ensures correct mating
- . EMI & RFI protection
- . Integral environmental seal
- . Pin & socket bodies in accordance with MIL-C-39029



CIRCULAR CONNECTORS

- . Contact arrangement: 6 to 21 poles
- . IP67 protection (mated)
- . Nominal current: 3 to 20 A
- . Temperature range -20° to 125°C
- . Tested based on VDE 0627/09.91
- . Variable shielding connection based on standard EMC DIN EN 50082



QUICK DISCONNECT CONNECTORS

- . Plastic shelled
- . Quick disconnect enable easier mating and unmating cycles
- . 3 to 25 contacts
- . Crimp, solder terminations





Europe

Hypertac Limited

Waterloo Road, London NW2 7UH, UK

Telephone: +44 (0) 20 8450 8033

Facsimile: +44 (0) 20 8208 4114

e-mail: info@hypertac.co.uk

Hypertac SpA

Via P.D. Da Bissone 7A, 16153 Genova-Sestri P., Italy

Telephone: +39 0 10 60361

Facsimile: +39 0 10 6036280

e-mail: info@hypertac.it

Hypertac S.A.

31 rue Isidore Maille,
76410 St. Aubin Lès Elbeuf, France

Telephone: +33 (0) 2 32969176

Facsimile: +33 (0) 2 35787746

e-mail: info@hypertac.fr

Hypertac GmbH

Ulrichsbergerstraße 17,
94469 Degendorf, Germany

Telephone: +49 (0) 991 250120

Facsimile: +49 (0) 991 2501244

e-mail: info@hypertac.de

Asia

Hypertac China

Suite 601, Novel Plaza,
128 Nanijing Road West, Shanghai 200003, P.R. China

Telephone: +86 21 6350 1735

Facsimile: +86 21 6350 1398

e-mail: infochina@hypertronic.com

Hypertac Japan

Meisho Building 3F 1-78, Issha,
Meito-Ku, Nagoya, Aichi 465 - 0093 Japan

Telephone: +39 0 10 60361

Facsimile: +39 0 10 6036280

e-mail: info@hypertac.it

America

Hypertronics Corporation

16 Brent Drive, Hudson, MA 01749-2978, USA

Telephone: +1 (0) 978 5680451

Facsimile: +1 (0) 978 5680680

e-mail: info@hypertronics.com

www.hypertac.com